

WIRELESS

WORLD

MONTHLY 3^D

Engineering
Library
620.5
W8
V192

UNIVERSITY OF MICHIGAN
LIBRARY

NOV 16 1914
LIBRARY

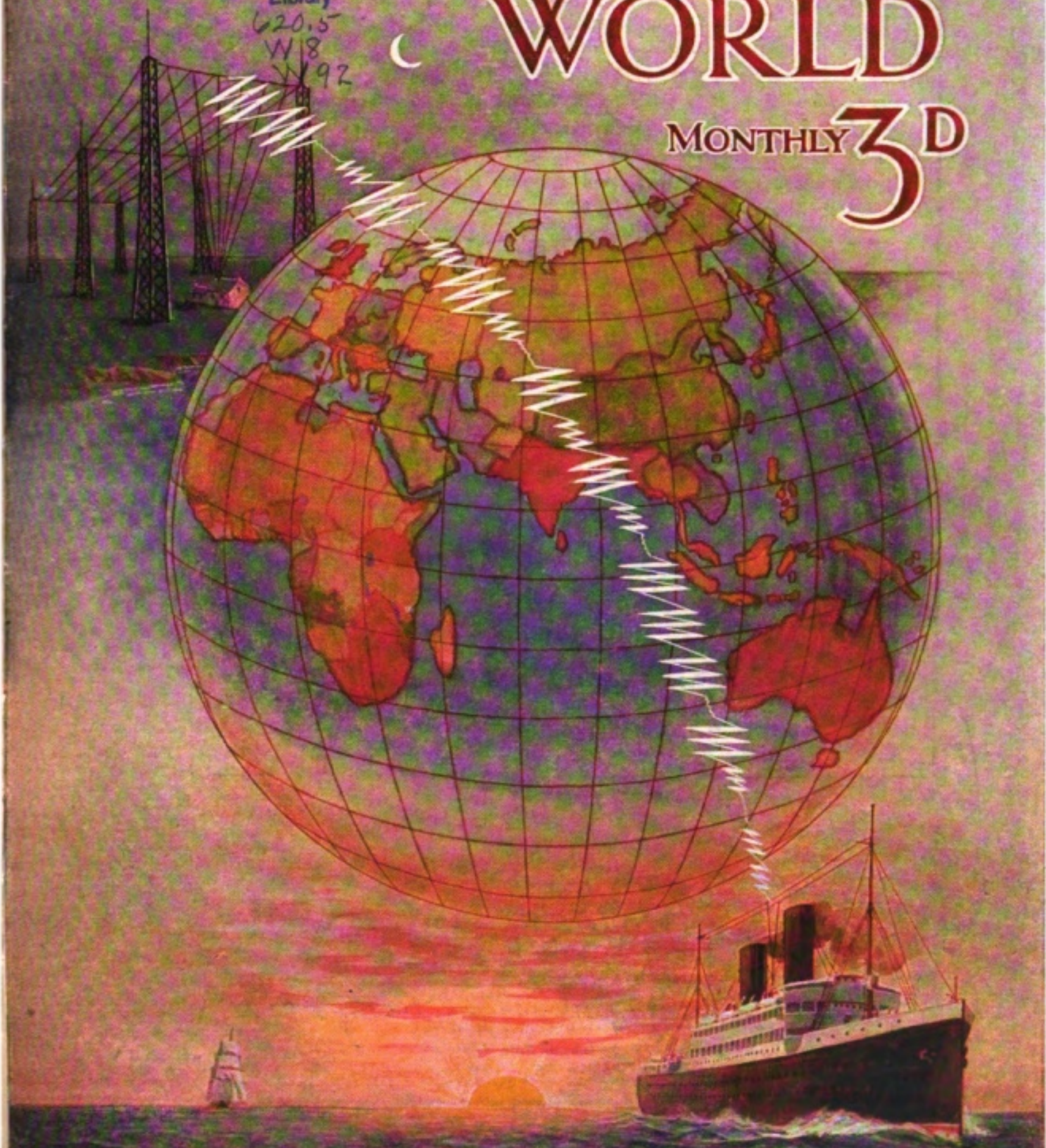

Sullivan Instruments

Sullivan "Universal" Galvanometers and Shunts for Land and Sea Use

Testing and Signalling Instruments of every description for Submarine Cables.

SULLIVAN TELEPHONE RECEIVERS for Wireless Telegraphy and Telephony, as used by the principal Governments and Wireless Telegraphy Companies—resistance values from 5 to 15,000 ohms.

Fast Speed Wheatstone Automatic Transmitters and Receivers, guaranteed at 400 words per minute, and Wheatstone Apparatus generally.

Precision and Standard Measuring Equipments for D.C. and A.C. (high frequency) determinations, Condensers of Low Power Factor, etc.

All instruments guaranteed, and accompanied, if desired, with Certificates of Accuracy from the National Physical Laboratory at cost price.

H. W. SULLIVAN,

Winchester House, London, E.C., England.

Works: Liverpool House, Middlesex Street, London, E.C.

Telegrams: "Deadbeat, London."

Telephone: { Office: 3518 London Wall.

{ Works: 3518a " "

Codes: Western Union (Universal Edition); A.B.C. (5th Edition); Engineering (2nd Edition). "

Silk and Cotton Covered H.C. Copper Wire, Resistance Wires, Fuse Wire,
Binding Wires, Charcoal Iron Core Wire, Asbestos
Covered Wire

P. ORMISTON & SONS, 79 CLERKENWELL ROAD
LONDON, E.C.
Established 1793. 13259 Central.

Braided
and Twisted Wires, Bare
Copper Strand & Flexibles of any Construction, Wire
Ropes & Cords, down to the finest sizes, in Galvanized Steel, Phosphor Bronze, etc.

NORMAN, SMEE & DODWELL

MANUFACTURERS OF HIGH-CLASS VARNISHES for Coach
Builders and Decorators, Railway Carriage and Locomotive Builders, and
Ship Builders Special Insulating Varnishes for Electrical Purposes

Offices and Factory: MILES LANE, MITCHAM, SURREY.



"Wireless" TELEPHONE RELAY

IMPROVED FORM will MAGNIFY CURRENT over 100 TIMES.

For INCREASING the RANGE of a Receiving Station.
For RECORDING Messages and TIME
SIGNALS.
For operating LOUD SPEAKING TELE-
PHONES.
For working CALLS and RELAYS.

Also BEST RECEIVERS made for Wireless and other RELAYS
and Loud Speakers.

For Particulars and Prices apply Patentee and Sole Manufacturer,
S. G. BROWN, 4 Gt. Winchester St., London, E.C.



Please mention "The Wireless World" when writing to Advertisers.



Vol. 2.—No. 20. (New Series)

November, 1914.

Subscription
5/0 per annum
post free.

Price 3d.
Post Free 5d.

Commercial Telegraphy in War

THE censorship restrictions on commercial cabling have given rise to a grievance among business firms which has been widely ventilated in the Press during the past month. Immediately after the declaration of war the use of codes, and even telegraphic addresses, was strictly prohibited, and merchants have since been compelled to use only plain language in any communications to their correspondents abroad. The result has been a proportionate increase in the cost of telegraphing, the expense being in many cases prohibitive. The Government have now promised a measure of relief to business firms in respect of code messages, but, at the time of writing, their proposals have not been announced.

Those who took part in the discussion of the question seem to have been under the impression that the relief which they sought would only be possible by relaxing the censorship restrictions, and they have singularly ignored the existing means for keeping down their cable bill during this abnormal period, without calling upon the authorities to adopt measures which might do even more harm to the national interests than any censorship restrictions could. The substance of the discussion is that for business purposes rates should be temporarily reduced to such a figure that cabling in plain language would be no more costly than was cabling before the outbreak of war. The cable companies have, so far, shown no disposition to make a concession in this direction on their own initiative, and in some quarters it has been urged that if

the Government are not prepared to allow the use of even one of the recognised codes, they should agree to make good to the cable companies any shortage of revenue that might result from a temporary reduction of rates. It is, of course, assumed by those who put forward such a proposition that the only means of telegraphic communication is by cable. They forget that where wireless telegraphy enters into competition with the cable services, it has not only brought down the rates of the latter, but it is even cheaper than the reduced rates. This beneficial competition is, at present, limited to trans-Atlantic telegraphy, but will soon make itself felt in all parts of the world. It is a branch of service, however, which is of sufficient magnitude and importance to impress upon the commercial community that, so far as a large portion of foreign and colonial trade is concerned, no unnecessary hardship need be suffered while the use of telegraphic codes is in abeyance. The advantages of the Marconi telegraphic service are recognised in all departments of British industry, and no better evidence of its reliability and economy is required than the extensive use now made of that service by the great newspapers of England, the United States and Canada. The fact that the Marconi system is now developed and perfected, has been found adequate to meet the requirements of the Press, and that it is a medium which is employed to the fullest extent of its present capacity for ordinary commercial correspondence, stamp it as a service of great public utility.

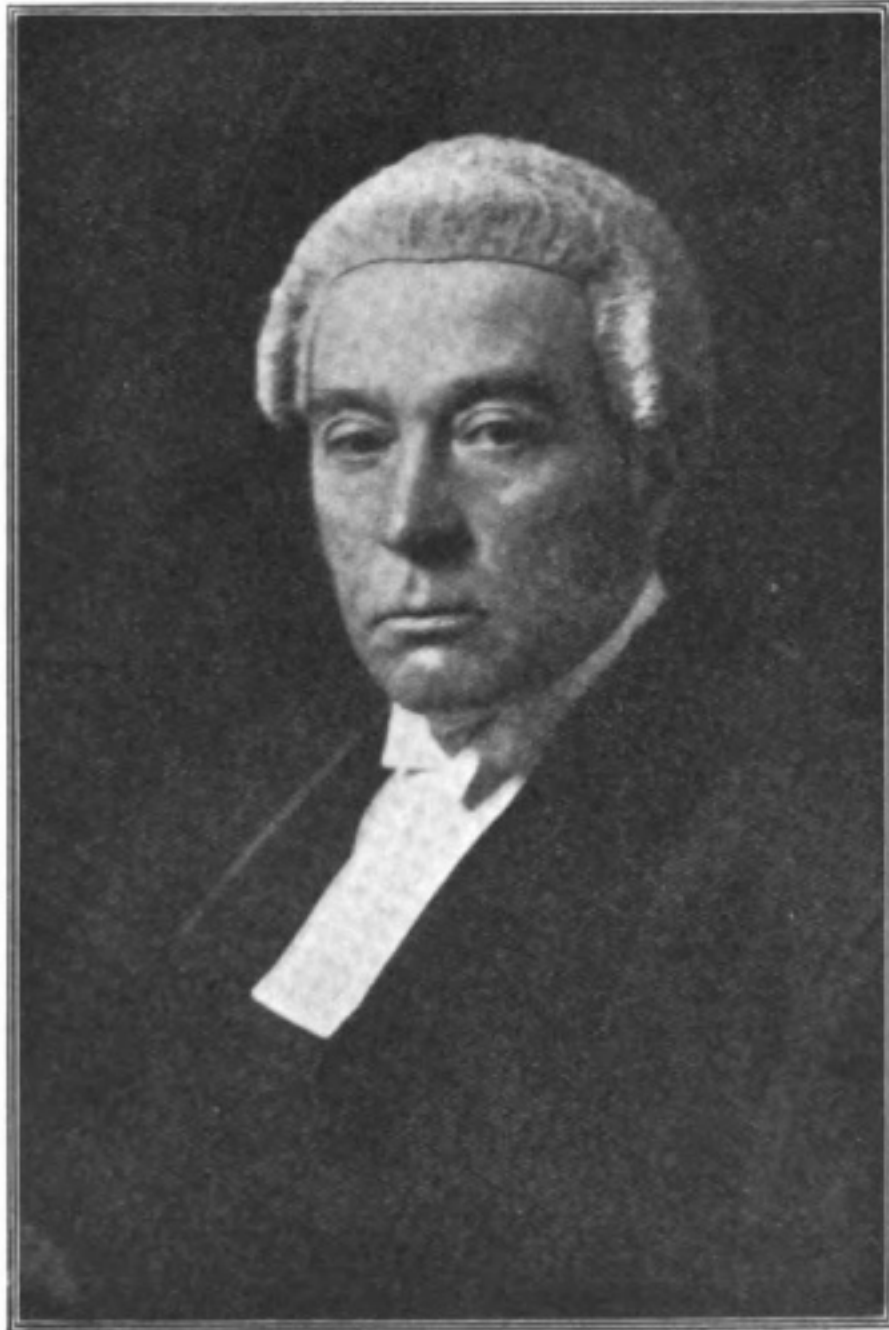

THE RT. HON. LORD MERSEY.

Personalities in the Wireless World

THE RIGHT HON. LORD MERSEY

HUMANITARIANS have received a shock by the outbreak of so terrible a war among civilised races knit together by many bonds both of friendship and sympathy. Where are our principles of brotherhood?—they will ask. Is our ultimate ideal a chimera—a will-o'-the-wisp?

Is it the battle nought availeth,
The suffering and the wounds are pain,
The enemy fainteth not nor faileth
And as things are they must remain?

The answer to such despondency is emphatically "No!" "If hopes are dupes, fears may be lies." That is the reply of the clear-sighted man who looks further afield than to the present turmoil. Hope—a serene hope—bids him see, in the outcome of these terrible events, a new earth where the standard of peace, planted more firmly by the hand of heroes, will float above us as an ensign to the people. Then shall we pick up the broken threads of our civilisation, we shall wage war—the more earnestly for the enforced inaction—on our heritage of suffering. The safety of human life will be our aim. Once again international committees for the safety of life at sea will sit to revise the work already carried out in this beneficent cause, and possibly later experiences will enable them to add to that work. When this time arrives we shall be the more able to appreciate the recent work of Lord Mersey in this cause. He has brought to this public service a splendidly logical mind, and one acquainted with the intricacies of international law. Moreover, he has thrown himself wholeheartedly into his task, and enthusiasm is always the key-stone for success in whatever its aim. It is the motive power which destroys obstacles, however impregnable. It is the touch-stone of our existence.

The Canadian Government was well

advised when it appointed Lord Mersey president of the enquiry into the *Empress of Ireland* disaster, and, as a result, his report on that occasion is a document of the highest importance to all who are interested in the safety of life on sea. In it Lord Mersey has pointed out the lines on which further work may be carried out advantageously, and the study of this document will show that his lordship is fully alive to the importance of wireless telegraphy as a life-saving agency. On that occasion he expressed himself in terms of the highest approval on the efficiency of the Marconi service of operators.

Among the other services of Lord Mersey to the nation have been his representation in Parliament of the borough of the Exchange Division of Liverpool, his work on the South African Committee of the House of Commons for the year 1896-97, and in 1902 on the Royal Commission for Revision of Martial Law Sentences in South Africa, also as President of Railway and Canal Commission, 1904-1908. From 1909 to 1910 he was President of the Probate, Divorce and Admiralty Division of the High Court of Justice, and it was on his retirement from this office that he was created Baron Mersey of Toxteth. Previously, in 1897 as John Charles Bigham, he had received the honour of knighthood.

Lord Mersey was born at Liverpool on August 3rd, 1840, and was educated at the Liverpool Institute, and afterwards at Berlin and Paris. He was called to the Bar in 1870, and thirteen years later became Queen's Counsel. In 1886 he was made a Bencher of the Middle Temple.

In the present crisis the British Government, aware of Lord Mersey's intimate knowledge of Marine Law, have appointed him President of the Prize Courts to adjudicate on vessels taken from the enemy and held as prizes of war.

Determination of Wave Length in Radiotelegraphy.

By A. S. BLATTERMAN.

[This article is reproduced from the "Electrical World" of New York. It deals with the relation that should exist between the length of wave, size of antenna and current produced therein in order to obtain maximum transmission.]

WHEN the size of aerial and available power are fixed the selection of wave-length has an important effect on the range of the station. It is well known that the radiation component of the aerial resistance is greater for short waves. Yet short waves suffer greater absorption than long ones, and the question therefore arises as to how we shall compromise in the selection of the proper wave-length so as to obtain considerable radiation and yet use a wave which is not highly absorbed. In short, what is the wave-length which will be most effective with the power and the antenna at hand?

Besides the variation with wave frequency in radiation and in absorption, another factor influencing the choice of wave-length is the similar change in the antenna current. The aerial current with a given potential maximum is greater for short waves. However, if attention is confined to the aerial current alone, without respect to potential, this can, with properly designed inductances, be made to be practically constant throughout a large range of wave-lengths. When the power in the condenser circuit is invariable the aerial current is affected only by the total equivalent resistance of the given aerial circuit. It is independent of an added self-inductance, altered wave-length or capacity, and the effect of the addition of any foreign element into the circuit, such as an inductance for the purpose of raising the wave-length, must be judged solely by its ohmic resistance.

The fourth influencing fact in the selection of wave-length is the distance over which transmission is to be effected. Both theory and practical experience point to the

necessity of using long waves for long-distance transmission; but when comparatively short distances are to be covered on low power the use of a long wave presents no advantage whatsoever and, as has been

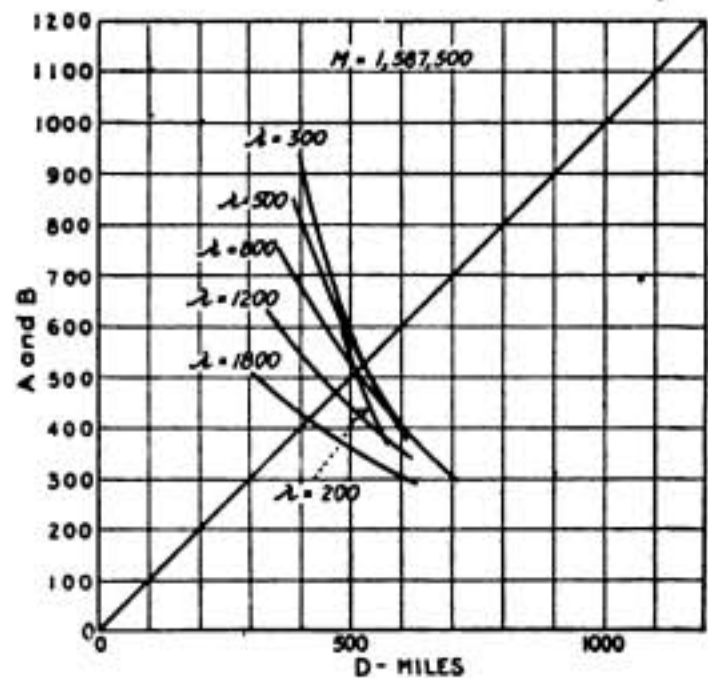

Fig. 1—Signalling distance for different wave-lengths with factor $M = 1,587,500$

shown, may even result in a weakening of received signals.

It is proposed here to investigate the empirical equation worked out by Austin for daylight transmission over sea-water with a view of determining the best wave-length to use for transmission over a given distance for a given antenna and a given aerial current. Conversely, the curves hereinafter presented can be used to determine the range of a station when the wave-length, antenna height and current are known.

An interesting paper* by Prof. A. H. Taylor has recently appeared in which experimental data are presented showing that a distinct optimum wave-length does exist. For the 1-kw. station with which his experiments were made this wave-length was approximately 460 m. and was the minimum at which the station could be efficiently operated. It is interesting to compare his practical results with those

λ = wave-length (kilometres).
 d = distance between stations (kilometres).
 α = an absorption co-efficient.
 ϵ = 0.0015 for transmission over sea-water.

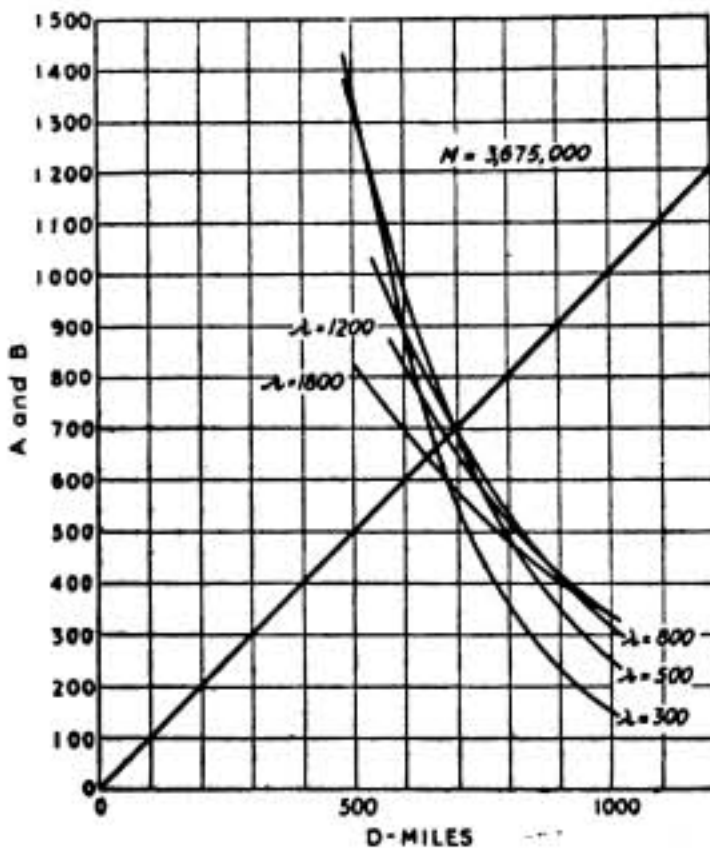

Fig. 2—Signalling distance for different wave-lengths with factor $M = 3,675,000$

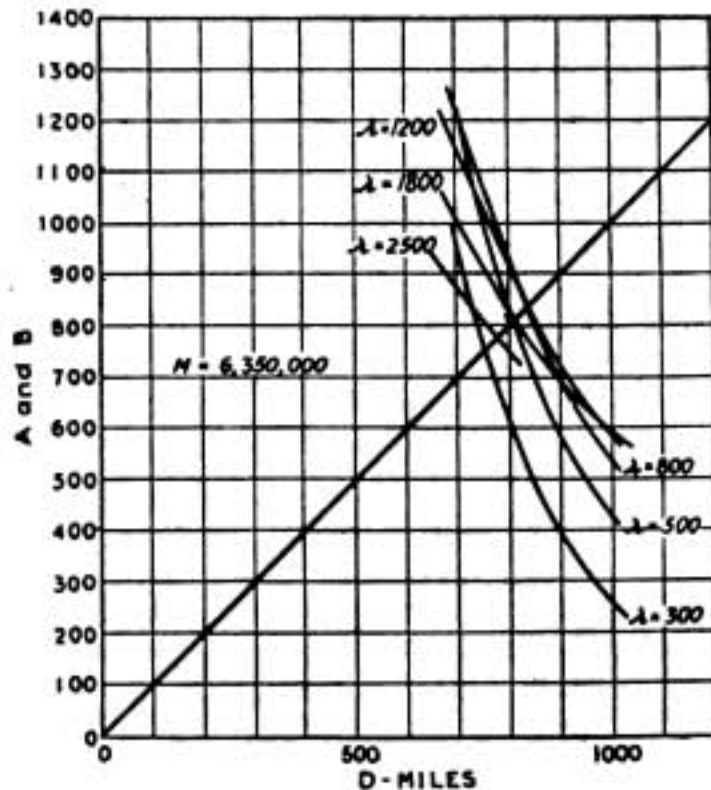

Fig. 3—Signalling distance for different wave-lengths with factor $M = 6,350,000$

which could have been predicted by the use of a method such as that quoted in the present paper. Considering the fact that his experiments were carried out over dry prairie land the agreement seems very good. The equation stated† by Austin is :

$$I_r = K I_s \frac{h_1 h_2}{\lambda d} \epsilon^{-\alpha d} \sqrt{\lambda}$$

where
 I_r = current received through 25 ohms equivalent resistance (amp.).
 I_s = sending aerial current (amp.).
 h_1 = height of sending aerial (kilometres).
 h_2 = height of receiving aerial (kilometres).

* "Optimum Wave-Length in Wireless Telegraphy," by A. H. Taylor, *Physical Review*, Vol. I., No. 4, April, 1913, pp. 321-325.

† Austin, L. W., *Bulletin Bureau of Standards*, 1911, Vol. VII., No. 3, pp. 315-363, "Some Quantitative Experiments in Long-Distance Radiotelegraphy."

The constant k has been determined by Austin to be 4.25 for the flat-top aerials on the cruisers used in his experiments.

As far as I am aware, there have not yet been collected and published any adequate data from which the values of α and k for overload transmission could be determined, though it is proposed to make experiments for this purpose at Washington University, St. Louis, Mo. As Taylor points out, it seems likely that transmission takes place according to the same general law of variation with distance over land as over sea.

The units of Austin's original expression are inconvenient for practical computations, and I am therefore giving the expression with its co-efficients modified so that h_1 and h_2 may be measured in feet, d in miles, λ in meters, I_r in micro-amperes, and I_s in amperes. These are the units commonly used in this country in the measurements of the respective quantities.

$$I_r = \frac{635 I_s h_1 h_2}{\lambda d} \epsilon^{-0.0762d} \sqrt{\lambda}$$

An investigation of this equation shows, first, that there is a certain wave-length for

a given value of antenna height and current, which will give maximum range in transmission. But, besides this, this best wave-length can be determined, and with it the concomitant values of antenna current and elevation for any given distance.

The first step is to solve the equation for distance; but, since this factor enters both as a co-efficient and as an exponent, there is no explicit solution, and graphics must be used* to evaluate d in terms of the other quantities.

The equation may be written :

$$d - \frac{M}{\lambda \epsilon^{0.0762d/\sqrt{\lambda}}} = 0 \quad (1).$$

where

$$M = \frac{635 I_r h_1 h_2}{I_s}$$

and is evidently a parameter involving arbitrary constants.

The equation (1) is now of the form

$$A - B = 0$$

where

$$A = d$$

$$B = \frac{M}{\lambda \epsilon^{0.0762d/\sqrt{\lambda}}}$$

The variables d and λ can now be assigned different values and A and B calculated. A and B thus determined can be plotted on the same scale as ordinates against d . The plot A to d gives a straight line (since $A = d$). The plot of B to d gives a series of curves having parameter λ which intersect the straight line graph of A to d . At the points of intersection of the straight line and the B curves

$$A = B$$

and hence the distance d read off at this intersection is a solution of the general equation for any particular value of the parameter λ , as was shown by Hogan in the papers quoted.

The curves of Figs. 1, 2, 3, 4, 5 have been worked out in this way for different values of M . In calculating M it is necessary to know the value of receiving antenna current I_r . Austin has determined that this is about

10 micro-amperes for signals of just readable strength on ordinary apparatus and about 40 micro-amperes for fairly strong signals which can be read through moderate interference. It is likely that with modern apparatus these figures are conservative.

A glance at these curves of Figs. 1, 2, 3, 4, 5 shows that for each given value of M the

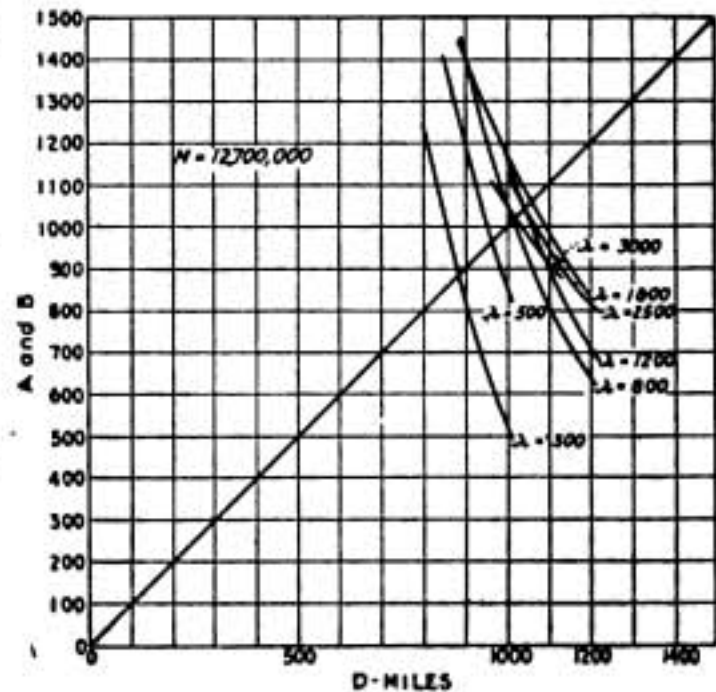

Fig. 4—Signalling distance for different wave-lengths with factor $M = 12,700,000$

solution for d increases with the wave-length up to a certain point; but beyond this point further increasing wave-length is accompanied by a decrease in distance.

If now the solutions for d at the different wave-lengths are read off and these values of d plotted against the wave-lengths to which they correspond, a series of curves are obtained having parameter M which exhibit distinct maxima of distance corresponding to a particular wave-length. See Fig. 6, which is drawn in this way.

For instance, if the value of M for a certain station is 3,675,000, which is true when $h_1 = h_2 = 100$ feet and $I_s = 5.8$ amp. for each 10 micro-amperes required in the receiving antenna, then Fig. 6 shows that the best wave-length to use is 700 m.; and for the assigned signal strength at the receiving station corresponding to 10, 20 or 40 micro-amperes in the receiving aerial which was used in calculating M the maximum range is 700 miles.

It will be noticed that as M increases—that is, as higher power and higher aerials

* Hogan, J. L., Jun., *Elec. World*, June 21st, 1913, pp. 1361-1366, "Quantitative Results of Recent Radiotelegraphic Tests Between Arlington, Va., and U.S.S. Salem," and *Proceedings, Institute of Radio Engineers*, July, 1913, pp. 75-102, "The Heterodyne Receiving System, and Notes on the Recent Arlington-Salem Tests."

are used or the signal strength at the receiving station becomes less—in other words, as the distance increases, the wave-length which gives maximum transmission

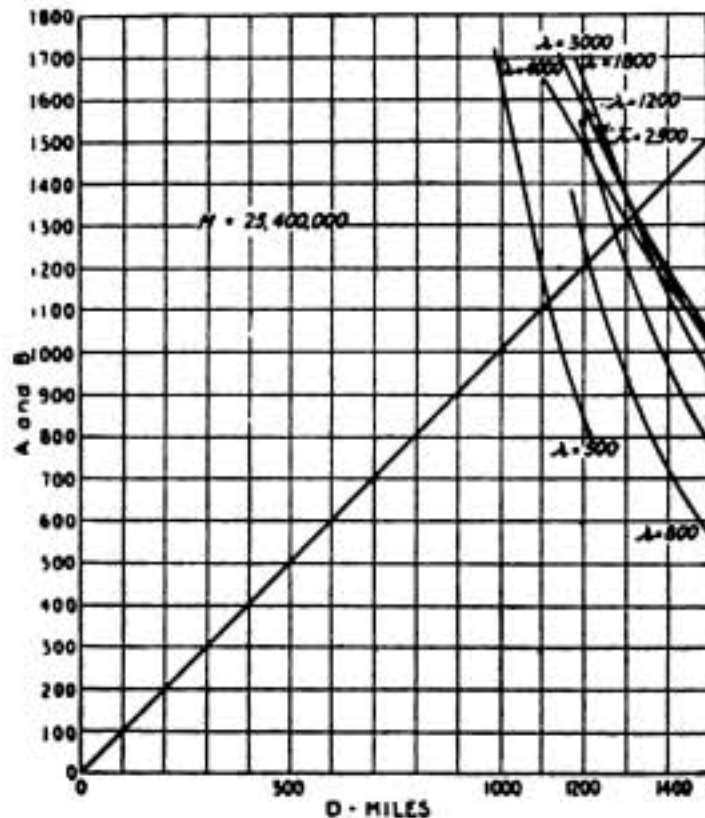

Fig. 5—Signalling distance for different wave-lengths with factor $M = 25,400,000$

becomes less sharply defined. The curves become flatter, and almost any wave for a considerable distance either side of the maximum will do almost as well as the optimum wave for maximum distance. A practical verification of this is found in some of the very long-distance tests which have been made in the past. Marconi has found that waves of 5,000 m. and 7,000 m. are about equally effective between his high-power transatlantic stations in Nova Scotia and Ireland, about 2,000 miles apart.

The wave-lengths for which d is maximum at the different values of M in Fig. 6 can now be plotted against the respective values of M and the curve marked "wave-length" in Fig. 7 obtained. This curve shows the best value of wave-length to use for different values of M . Similarly, the maximum distances of Fig. 6, at different values of M , which can be obtained by the proper selection of wave-length, can be plotted to M and the curve marked "distance" obtained, as in Fig. 7.

These curves of Fig. 7 can be used to determine the proper wave-length for trans-

mission over any distance up to 1,300 miles, and corresponding to this distance and wave-length the value of M required; or if M can be calculated from the dimensions of the sending and receiving aerials and the currents therein, the curves can be used to determine the greatest distance which can be covered with the assigned value of I_s , and simultaneously the wave-length which is proper to this distance and the power at hand. As an example of the first case, suppose that the maximum distance to be covered is 1,000 miles. The "distance" curve (Fig. 7) shows that M must be 10.6×10^6 . But the desired distance, 1,000 miles, can only be covered with this value of M when the wave-length used is that read from the wave-length curve (Fig. 7) corresponding to this M ($= 10.6 \times 10^6$)—namely $\lambda = 1,550$ m. A wave very much shorter or very much longer than this will reduce the range.

For any value of M a choice of antenna height and received signal strength immediately fixes the sending aerial current I_s , and this is a direct index of the power to be used in the sending station. If the antenna chosen is low, then a high value of I_s is necessary, whereas a smaller value of antenna current will have the same range if produced in a higher aerial. In other words, for the same range of transmission there are two alternatives, either higher tower and lower power, or higher power and lower tower. The choice lies between the initial outlay and running expenses, although for safer and handier operations, and freedom from occasional breakdown of apparatus, smaller power with higher tower would be preferable. The question is one of economy according to actual circumstances.

Figs. 6 and 7 show a peculiar fact of practical importance—this is, that the wave-length giving extreme range does not necessarily produce the strongest signals at shorter distances. At distances below the maximum, at which signals are just audible, the minimum value of M , and hence the greatest I_s , occurs at a shorter wave-length than that used for the maximum distance. This has been at least partially verified by Professor Taylor and reported by him in the above-mentioned paper.*

For a given pair of fixed stations the

* A. H. Taylor, *loc. cit.*

factor M is constant, for h_1 and h_2 are invariable and a change in the current in the sending aerial produces a proportional change in that at the receiver. The wave-

$$M = \frac{635 \times 12 \times 100 \times 100}{10} = 7.63 \times 10^6.$$

Referring to Fig. 7, the best wave-length for this station and the maximum distance which can be reached in daylight over sea-water when this wave is used are respectively 1,200 m. and 900 m. However, any wave between 800 m. and 1,600 m. would seem to give almost as good results (Fig. 6), and this fact might be used to advantage when it is desired to avoid interference without appreciably reducing the range of the station.

The dotted curves of Fig. 6 have been interpolated by drawing the curve marked "locus of maxima" and the use of Fig. 7. The blanks for other values of M can be filled in in a similar way, and these curves will then show the effect on range of changing from the theoretically best wave-length given in Fig. 7.

In conclusion, the graphical method of solving the Austin-Cohen equation, and particularly the curves of Fig. 6, show the great advantage of long waves for transmission over great distances, and at the same time the great disadvantage of long waves when only comparatively short distances are involved. These results are borne out qualitatively in practical experience, and they also agree with the rational equations of Sommerfeld* and others, which show that long waves must be used to cover great distances. The most important conclusion, however, is that though the optimum wave-length for a station does not appear to be a very accurately determinable quantity, yet for a given aerial and given power there is a certain wave-length which will give maximum transmission, and hence in designing and adjusting a transmitter it may be of importance properly to correlate the wave-length with the size of the antenna and the current produced therein.

At no time has the Marconi Company's transatlantic ordinary deferred night and week-end letter service been discontinued. On the contrary, it has proved of inestimable value to business firms by enabling them to telegraph to North America at rates one-third below cable rates.

* Sommerfeld, *Ann. d. Phys.*, Vol. XXVIII., 1909.

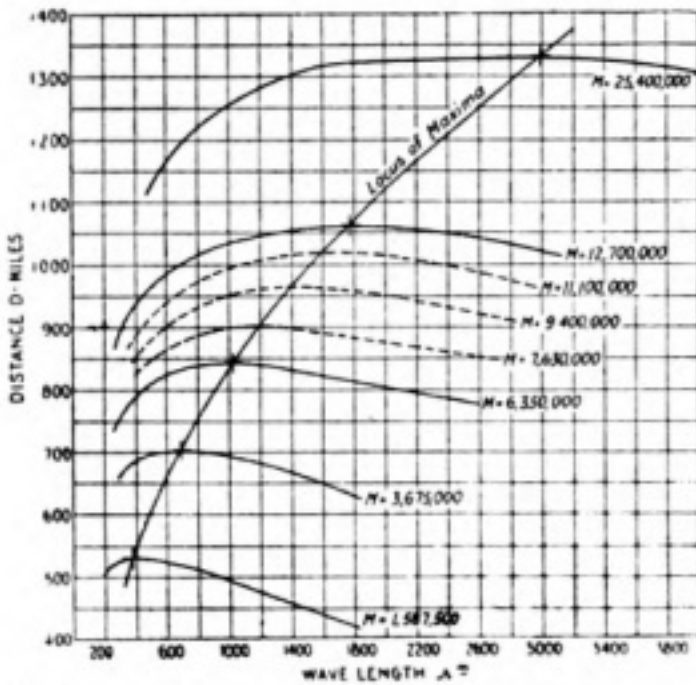

Fig. 6—Distance as a function of wave-length with different values of M

length which will allow communication with the least power is read from Fig. 7 and the sending aerial current required is calculated from the corresponding value of M by assigning to I_s the value 10 micro-amperes, which is Austin's figure for bare audibility of signal, or a larger value if louder signals are needed.

As an example, we may work out the extreme range and proper wave-length for

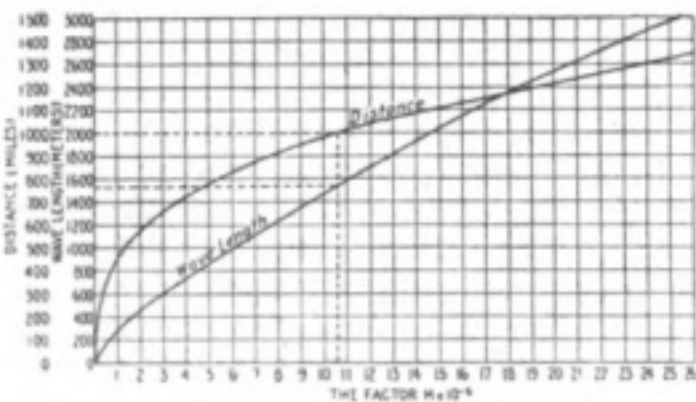

Fig. 7—Proper wave-length to use and value of factor M for transmission over a given distance

a station with 12-amp. aerial current, which corresponds to a moderately efficient 2-kw. set, and flat-top antenna 100 feet high, sending to a similar receiving station.

Digest of Wireless Literature

ABSTRACTS OF IMPORTANT ORIGINAL ARTICLES DEALING
WITH WIRELESS TELEGRAPHY AND COMMUNICATIONS READ
BEFORE SCIENTIFIC SOCIETIES.

Insulator Design.—

In a paper on "Insulator Design in relation to Lightning and other Static Disturbances," read before the American Institute of Metals, A. O. Austin referred to a large system with moderate rating and small conductors, and showed how such a system can withstand surges from switching and arcing better than a large system backed by large power houses and conductors. The latter system should be equipped with insulators commensurate in size with the load and its importance. The author suggests that inasmuch as surges affect the insulators more than lightning, inter-connected systems can obtain some measure of protection and be enabled to localise trouble by using steel conductors in tying in the various branches of the system, thus increasing the impedance and lessening the disturbances caused by surges. Routine tests are preferable to design tests, and according to the author there is a growing tendency to discard the oil puncture test and give more attention to routine tests, which eliminate all the weak members. An improved design of insulator has been introduced providing more strength to resist thermo stresses set up by uneven heating or by cement expansion, which tends to crack the insulators in time. This cracking may so weaken the insulator that the slightest surge causes trouble.

The Propagation of Electro-Magnetic Waves.—

On Monday, June 8th, the French Scientific Committee on Wireless Telegraphy, with the assistance of the Eiffel Tower transmitting station, organised a full day of trials with the object of ascertaining what variation electro-magnetic waves undergo in their propagation at different hours of the day. With this object in view several members of the Committee took up positions at varying distances from the transmitting station

(Eiffel Tower) so as to be able to study the respective power of the oscillations taken up by the aerial of their receiving station.

In a paper read before the Academie des Sciences, Paul Jegou describes a special arrangement used by him with satisfactory results. This consists in connecting a tuned circuit with an electrolytic detector, without either interior or exterior electric supply—that is to say, the electrodes of which (the anode and the cathode) are of platinum and dipped in a solution of acidulated water at 22° Baume (distilled water and pure sulphuric acid). What led to the adoption of a detector of such very mediocre sensitiveness was its perfect and almost marvellous constancy in its detecting results revealed by preliminary trials. The detecting circuit is homogeneous, and, consequently, does not record local electric disturbances, the detecting effect being solely due to the outward action of the tapped waves. Moreover, the short distance between the observer's station and the Eiffel Tower (about 200 kilometres) and the great development of aerial enabled such intense effects to be obtained as justified the use of this detector. In order to appreciate and compare the power of the sounds heard in the 'phones, the author used his special transformer coil (Comptes-rendus, June 15th, 1908) with induction, movable as regards the primary, which allows the coupling to be varied, and the relative position of the two coils to be recorded on a graduated scale. The advantages noticed by this method of measuring (by electrolytic homogeneous detector) and receiving are the following: *Detector*: (1) The perfect constancy of the sensitiveness of a receiver easy to fit up. (2) Owing to the feeble sensitiveness of the detector, the measures are not adversely influenced either by eddy-currents or by extraneous emissions. *Transforming coil with variable coupling*: (1) More marked indications than the method of the shunt

upon the receiver, because the total resistance of the detector circuit is modified to an appreciable degree. (2) The receivers may be touched anywhere without causing trouble in the local indicator circuit, inasmuch as they are in a circuit which is completely insulated from the detector circuit. It is, in fact, easy to distinguish the temporary interferences caused by contact with the hands or body with any part of the detector circuit. The following table shows the favourable effect of the night upon propagation:—

Mid-night	2 a.m.	4 a.m.	6 a.m.	8 a.m.	10 a.m.	noon
80	85	87	87	83	71	65
2 p.m.	4 p.m.	6 p.m.	8 p.m.	10 p.m.	mid-night	
No signals	72	72	77	80	88	

Production of Waves by Coupled Oscillation Circuits.—

In comparison with the direct excitation of the antenna, the indirect excitation by means of coupled circuits has the advantage that it permits the utilisation of a considerable amount of power, but it has the disadvantage that two waves of different frequencies and different damping are produced. In connection with the former, Emile Girardeau shows in *La Lumière Electrique*, that it is theoretically possible to realise a system of coupled oscillation circuits by which only a single oscillation is produced. He also describes the results of experiments made in the Central Laboratory of Electricity in Paris, which show that this single-wave arrangement gives a better efficiency than the usual methods of coupling.

Selenium.—

F. C. Brown contributes to the *Physical Review* an account of an experimental investigation of the crystal forms of metallic selenium and some of their properties. In this research a large number of new crystals of metallic selenium were formed, some of very large size. All of these forms, except one, are very transparent selectively to light, a large amount of light penetrating to a greater depth than 0.2 mm. All the forms tested are conducting, showing a specific conductivity varying between 200 and 10^7 . All the crystal forms increase

in conductivity when illuminated, and with but one exception they have been observed to be doubly refracting. The action of light is in the selenium itself and not at the contacts. Mechanical pressure produces a genuine change in the selenium, which may alter the conductivity more than a thousand times. The absolute change of conductivity in one crystal by constant illumination was proportional to the conductivity in the dark, when that conductivity was altered by pressures between one atmosphere and 180 atmospheres. The temperature at which the crystals sublimate in mass influences the character of the wave-length sensibility curves. The production of individual crystals of metallic selenium of large size opens up a wide field of investigation which promises to be free from some of the possible complexities in selenium cells.

Use of Closed Circuits.—

In the *Jahrbuch der Drahtlosen Telegraphie* F. Braun describes experiments carried out with closed oscillation receiver circuits, to ascertain how they may be used instead of the usual open type. A large rectangle of several turns of wire, suspended from a tower at some height above the ground, was first used in the experiments which were conducted between Strasburg and the Eiffel Tower, the signals observed being from the latter station. The direction of the incident radiation was determined by turning the coil through 180 degrees, and the strength of the signal received was determined with a unipolar detector and telephone by the shunted telephone method. Such a closed circuit may, therefore, be used to determine the strength and direction of the waves, and also the absorption of the waves and the effect of land obstacles. Wave length may be determined by using two coils connected together, and following the distance between them in the direction of the incident waves. A simple rectangle, with its plane vertical, closed to an oscillation circuit, with a capacity in one of the vertical sides, was then employed, the height of the rectangle being about 50 feet, and its length about 80 feet. The arrangement was in the shadow of a large building, and gave much better signals than an open sender of the same vertical height.

Wireless Time Signals.

An account of the progress which is being made in this important branch of "Astronomy" at the Observatories of Edinburgh and Greenwich.

IT is outside the scope of this article to discuss the principles on which radio-telegraphic time signalling is based. Readers who have not acquainted themselves with the subject and want to get a full and comprehensive study of this branch of wireless utility are advised to read the admirable articles by Mr. Arthur R. Hinks, M.A., F.R.S., which appeared in the Year Books of Wireless Telegraphy for 1913 and 1914. Suffice it here to give as a brief introduction to the report of the work which has been done during the last two years a short description of the main points in the principles on which the service is based. All who have had practical experience with the reception of messages are acquainted with the "signaux horaires" sent out by the Eiffel Tower from the Paris Observatory. These are based on the principle of the "vernier acoustic." That is, a clock at the Observatory beating 50 in 49 seconds is put into the circuit, and sends at each beat a very sharp signal, which in the telephone receiver is exactly like the tick of a clock to be compared with it. The comparison is made by the method of coincidences. The Paris signals gain rapidly on the clock and the coincidence of beats can be determined to within about one beat or a fiftieth of a second. During the space of nearly three minutes, or more precisely, 180 beats, that the signals last there will be three coincidences, and the mean of the three gives a comparison which may be relied on to well within the fiftieth of a second, or, in other words, well within the accuracy with which time can be determined and kept at a single observatory.

Now to explain how the observer is told the time of each beat of the "vernier acoustic." The series goes out at 11.30 in the evening. It is received at the Paris Observatory and compared with the standard clock. A few minutes' calculation gives the precise time of the first and last beats, and

these are reported to the hundredth of a second in a wireless message sent out from the Observatory immediately after the evening set of ordinary time signals, at about 11.50 p.m.

The institution of wireless telegraphy for this purpose was responsible for much greater attention by the Observatories throughout the world to this important subject, for remember, the determination of latitude and longitude, and consequently the accurate mapping of the world and of vast regions where the slow process of triangulation is impracticable, is intimately involved.

The British Observatories have not been behindhand in the reorganisation of this section of their work, as the reports by the Astronomers Royal of England and Scotland, from which the following extracts are taken, will show. The Report of the Astronomer Royal for Scotland refers to the new receiving wireless telegraphic apparatus which through the session 1913-14 was added to the Edinburgh Observatory, and adds: "The aerial runs from the cornice of the east dome to a mast at the west end of the grounds, level, at an average height of about 50 feet, and is about 300 feet in length. The receiving wire is led through the window of the chronograph room to a table where the remainder of the apparatus is arranged. Most of the apparatus was constructed in the Observatory. The signals are clear and good. On two or three occasions only the day-time signals from Norddeich have been inaudible. Besides the usual receiving arrangements, the provision includes an appliance for producing in the telephone suitable ticks from the clock Riefler for comparison with the Paris rhythmic signals or time-vernier. After a good deal of experiment on other methods, Riefler was made to drive the controlled clock in the lobby, to the pendulum of which a contact-maker was attached. On the receiving table there is an induction coil; the secondary is connected with the tele-

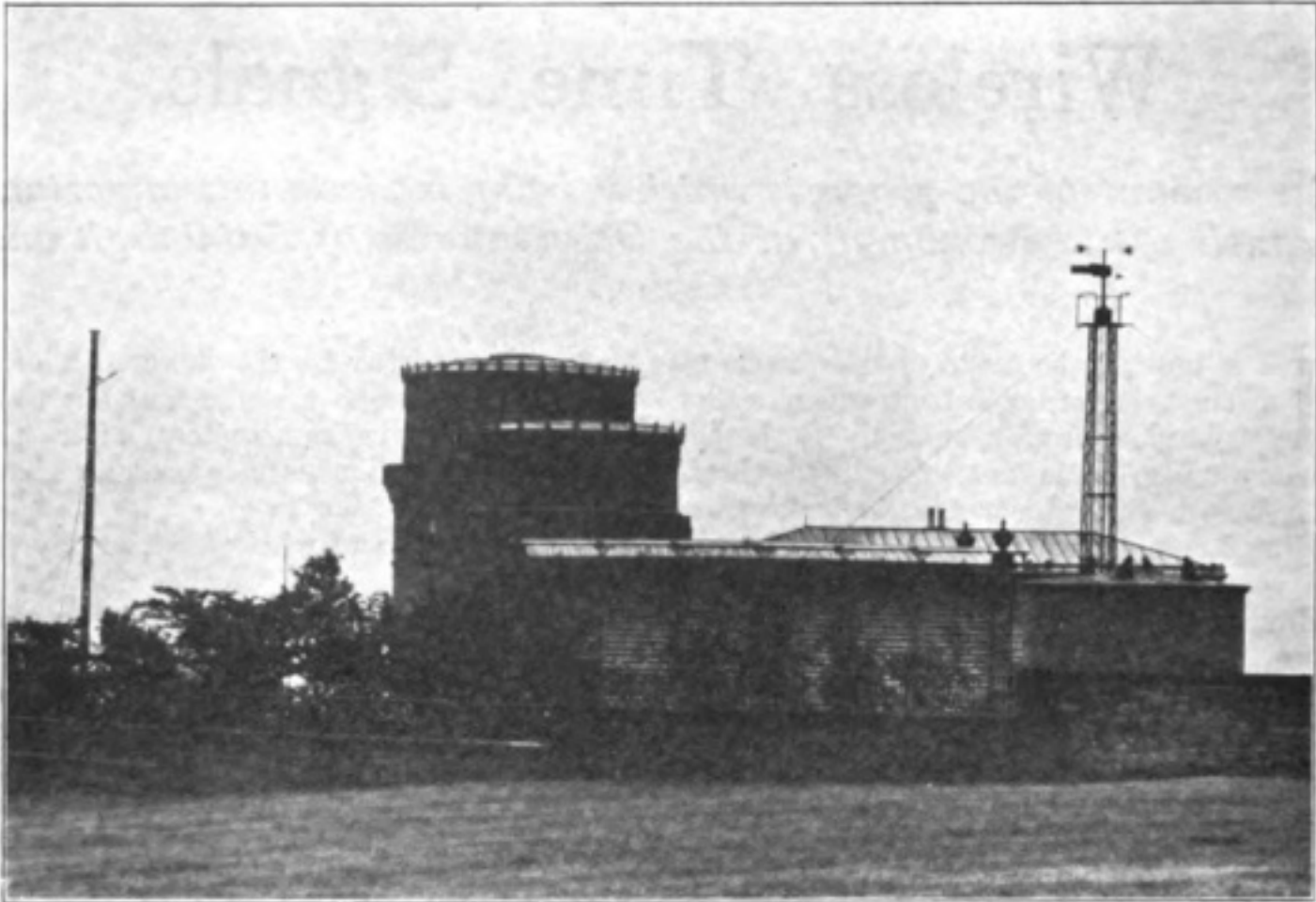

The Royal Observatory, Edinburgh, from the West, showing the Aerial.

phone, and the current from the lobby clock passes round the primary, which can slide within the secondary and thus regulate the intensity of the ticks. Between these ticks and Riefler's impress upon the chronograph tape there is a definite lag. This is determined by means of a time-vernier arranged for the purpose. A free pendulum, making a tick at each swing, is mounted on the pillar behind the observer; when set in motion it swings for several minutes without sensible acceleration, gaining one beat in about 54 upon a mean time clock. Its coincidences are taken for six or eight minutes in succession with the telephone tick and with the chronograph stroke alternately. The lag appears to vary very little from the amount 0.11s. *These appliances are considered an important addition to the Observatory,** and their arrangement upon the whole is satisfactory. The chief remaining difficulty is the current passing for the control of the town clocks and other controlled clocks in the Observatory. These currents are very audible in the telephone, though, of course, fully insulated from it. It is not possible to suppress them for many minutes together or the system of clocks

would go wrong, but a switch upon the receiving table permits one to suppress them while one is attending, for example, to the coincidences with the Paris rhythmic signals. The fault will be cured when some of the circuits are re-wired.

"The following examples will illustrate the character of the comparisons obtained from these signals, which are so arranged that one can derive from them the comparison of one's own clock with the adopted time of all participating observatories as sent out from Paris. After March 11th some alterations were made in the contact wheel; from this date onwards the correction for lag has been applied; for the earlier date it was not satisfactorily determined.

WIRELESS OBSERVATIONS OF CLOCK CORRECTION,
PARIS-EDINBURGH.

March.	Secs.	Observer.	March.	Secs.	Observer
3	+0.12	J. S.	18	+0.10	J. S.
5	.12	J. S.	19	.08	J. S.
6	.08	R. A. S., J. S.	20	.10	R. A. S.
7	.12	J. S.	21	.11	J. S.
9	.15	J. S.	23	.15	J. S.
10	.12	R. A. S.	24	.11	R. A. S.
11	.10	J. S.	25	.17	J. S.
12	.07	R. A. S.	27	.13	J. S.
13	.10	J. S.	28	.15	R. A. S.
14	.10	R. A. S.	30	.15	R. A. S.
16	.05	J. S.	31	.14	J. S.
17	.08	R. A. S., J. S.			

* The italics are ours.—Ed. W.W.

It will be noted that there is no sign in these of the personality of the observer.

"It is clear from these comparisons that the Paris time-vernier, with its apparent complete freedom from personality, must rank as one of the most precise and reliable of modern astronomical resources."*

"The comparisons with the ordinary time signals sent out from Paris and Norddeich are naturally less precise, but they present some features of interest. Out of 30 times when the Paris signals were observed by both Mr. Storey and myself we have a mean discordance of ± 0.05 , and similarly from 17 observations of Norddeich ± 0.08 without any personality. If we eliminate the reference to Edinburgh by subtracting the correction as determined from the rhythmic signals, we obtain an equation from the Paris ordinary signals to the time of the rhythmic signals, and similarly from the Norddeich

signals, as under. The time taken is from the mean of all observations by both observers on each day.

Date.	Paris.	Norddeich.	Date.	Paris.	Norddeich.
Feb.	Secs.	Secs.	Mar.	Secs.	Secs.
10	+09	+09	12	-10	-11
11	+05	+15	13	-10	-14
12	+09	+14	14	-10	+05
13	+03	+14	15	+06	+13
14	+02	+03	16	+07	+03
15	+07	+03	17	+04	-00
16	+02	+11	18	+07	+06
17	+07	+04	19	+10	+14
25	-05	-07	20	-00	-04
26	-12	-12	21	+04	-06
27	-13	-10	22	+06	-
Mar.			23	+03	-04
3	-18	-12	24	+13	+08
5	-13	-20	25	+01	-01
6	-05	-12	26	+10	-04
7	-04	-18	27	+11	-00
8	-14	-16	28	+13	-
9	+07	-08	29	+10	-06
10	-01	-17	30	-04	+07
11	-08	-13	31	-02	-10

From this it appears that each set of ordinary signals as recorded here shows a fluctuation

* The italics are ours.—ED. W.W.



INTERIOR OF WIRELESS ROOM, EDINBURGH OBSERVATORY.

Our illustration shows the table with the receiving apparatus. The induction coil is connected to the contact-maker of the clock. The chronograph on which the Observatory clocks register is seen at the right-hand top corner.

running in amplitude to between one and two tenths of a second.

"Since May 28th the observed differences of time as given by the rhythmic signals between the Paris and Edinburgh clocks has been telegraphed to Paris on the following morning.

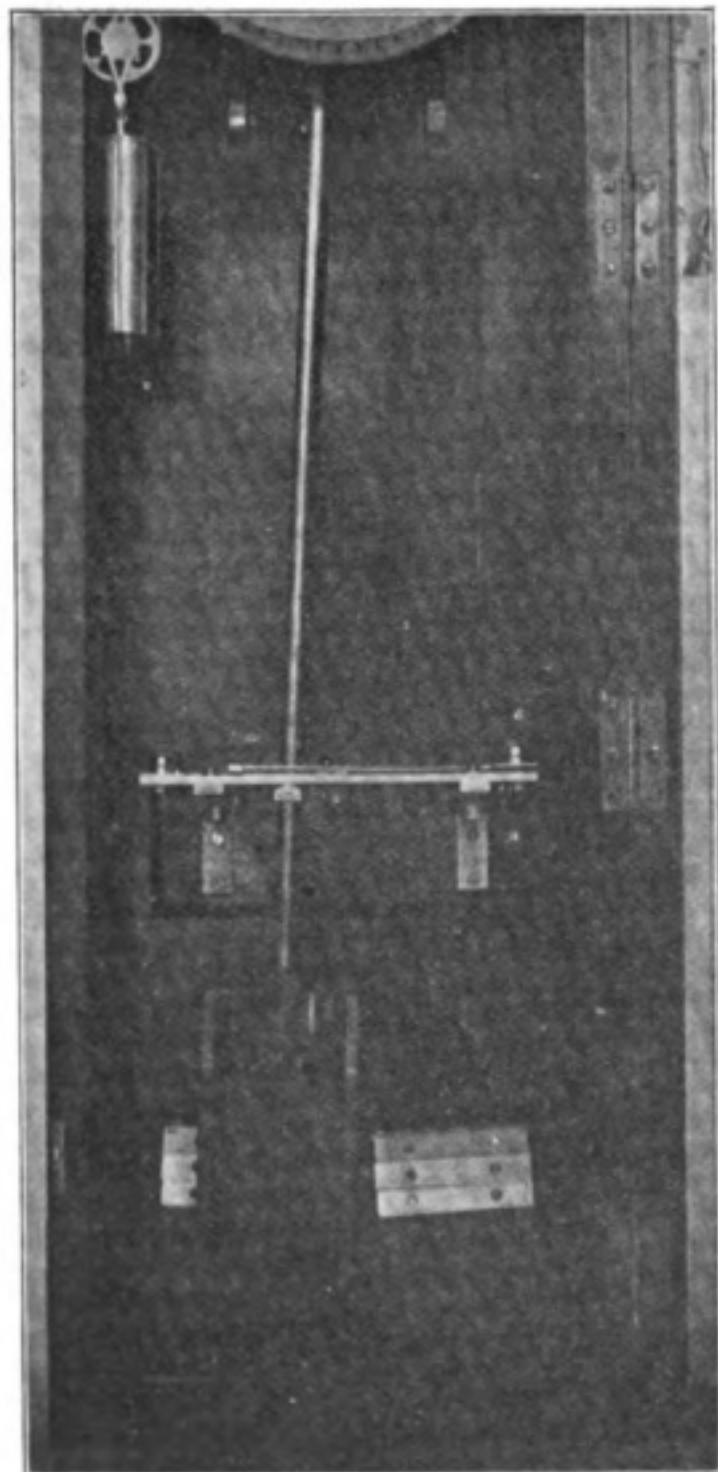

The controlled clock pendulum with contact-maker attached. At each swing—i.e., each second—a tick is sent to the wireless operator.

"It is well known that as soon as the 11.45 p.m. time signals from Paris have been sent, they immediately send the times of the first and last signals of their rhythmic set. These, compared with the times of their reception as observed with the Observatory clock, give

the difference Paris *minus* Edinburgh, the mean of the first and last signals being adopted.

"Thus, the telegram sent on the morning of July 31st read as follows: 'Observatoire Paris 15309, very good'—that is 'To the Observatory Paris—Your time is .15 of a second later than Edinburgh.' The last occasion on which we obtained stellar observation to check our clock was July 30th, and as a check to the receiver on the accuracy of the transmission the figure 9 = the sum of the preceding four figures = 1 + 5 + 3 + 0, the last two words indicating that the reception of the signals was 'very good.'"

The Report of the Astronomer Royal from Greenwich Observatory gives us the following information:

"An apparatus was set up on July 5th, 1912, for the reception of the wireless time-signals from the Eiffel Tower and Norddeich. The signals have been constantly observed by Mr. Lewis and Mr. Bowyer since this date, the morning signals being observed each day (except Sundays). The night signals from the Eiffel Tower have been observed on 128 and the rhythmic signals on 82 occasions. The night signals from Norddeich have been observed on 124 occasions. The morning signals from the Eiffel Tower were observed by both Mr. Lewis and Mr. Bowyer on 167 days: there is a mean difference $L - WB = -s.066$ in their times of observation with an accidental discordance of $\pm s.06$ between the observers. Similarly in the receipt of the Norddeich signals the two observers showed a mean personal difference $L - WB = -s.0433$ and a similar accidental discordance. Thus the ordinary signals are observed by either observer with a mean error of less than $\pm s.05$.

"As regards the actual difference between the time sent out by the Eiffel Tower and that of the Greenwich 10 hour and 1 hour signals, from 184 observations Mr. Lewis makes the Eiffel Tower Signal $0s.256$ late on Greenwich, and Mr. Bowyer, from 234 observations, makes it $0s.313$ late. It is supposed that the difference is mainly due to the difference of personal errors of the Standard Observers at Paris and Greenwich. The mean discordance after allowing for this constant difference is $\pm s.11$.

"The following table shows the actual differences found during May, the mean of

the two observers being taken after allowance for their constant differences :

May	Secs.	May	Secs.	May	Secs.	May	Secs.
1	+0.35	9	+0.46	17	+0.20	25	—
2	.42	10	.39	18	.28	26	+0.31
3	.35	11	—	19	.26	27	.33
4	—	12	—	20	.28	28	.32
5	.46	13	.35	21	.28	29	.21
6	.43	14	.32	22	.29	30	.37
7	.30	15	.18	23	.28	31	.40
8	.34	16	.13	24	.29		

EIFFEL TOWER.

Observer.	No. of Obs.	Signal late on G.M.T.	Personal Equation.	Mean Discordance.
		secs.	secs.	secs.
L. (Morn) ..	412	0.002	—	±.110
W. B. (Morn) ..	539	.044	—	±.114
L.-W. B. ..	375	—	.057	±.060
Rhythmic Signals	175	.041	—	±.065
W. B. (Night) ..	256	.050	—	±.122

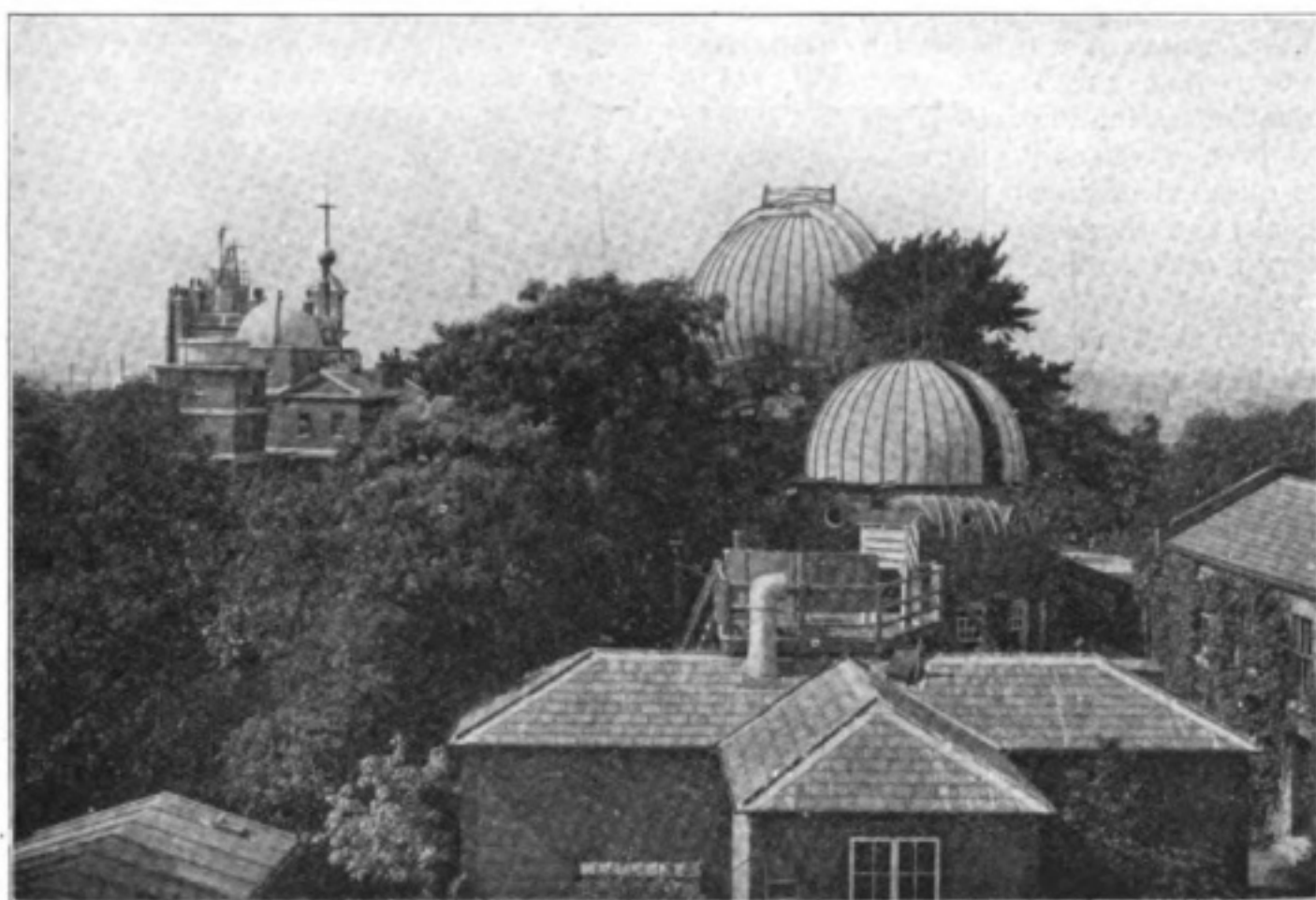

Exterior of Greenwich Observatory.

“ The Norddeich signals are, according to 160 observations of Mr. Lewis, 0s.297 late on the Greenwich time signals and 0s.340 late according to 229 observations of Mr. Bowyer. Allowing for this there is an accidental discordance of ±0s.23.”

The following year Mr. Maunder again referred to the time signals in the following terms :

“ The signals from the Eiffel Tower and Norddeich have been regularly received and compared with the Greenwich time. The results to 1914, May 10th, using the impersonal micrometer of the altazimuth as the standard for the personal equations of the Greenwich observers, are as follows :

NORDDEICH.

Observer.	No. of Obs.	Signal late on G.M.T.	Personal Equation.	Mean Discordance.
		secs.	secs.	secs.
L. (Morn) ..	336	0.016	—	±.225
W. B. (Morn) ..	526	.060	—	±.209
L.-W. B. ..	300	—	.051	±.075
Rhythmic Signals	—	—	—	—
W. B. (Night) ..	242	.062	—	±.214

“ A ‘ field set ’ of Mr. S. G. Brown’s relays and syphon recorder were obtained in March, and very satisfactory records have been obtained on twenty-five occasions.”

The Astronomer Royal’s remarks concerning Norddeich are at the present minute

particularly interesting, not to say pathetic. The events of the past few weeks have made a great difference in the *status quo* of this important station. There is no time for time signals, and what was once the disseminator of valuable and accurate information is, under the present jurisdiction of the War Lord and his minions, an instrument for the publication of questionable information and reports of what Mr. Punch jocularly terms "wireless victories."

But this is in parentheses. To conclude in all seriousness, it will be seen by the above reports that much valuable attention has been given to the question of time signals, and there is every reason to believe that in the future interest in this subject will not only continue at the same high level, but will be augmented until we shall reach a very high perfection in this branch of our geographical economy. The general public will never be aware of the great influence which it has already asserted and will continue to assert over public affairs. But that does not matter; the work will continue all the same, for like all good things the virtue of it is its own reward. Only this state of affairs urges us to the philosophical reflection that we do not appreciate, often we do not even realise, the benefits which it is our lot to enjoy.

Instruction in Wireless Telegraphy.

AN ANNOUNCEMENT.

IN the September issue of this magazine we announced the postponement of the articles of Instruction in Wireless Telegraphy. At the same time we expressed our hope that the series would shortly be

recommended. Up to the present this has been impossible, but in the December issue we shall include the fifth of the series, and we have hope that henceforth they will appear without intermission month by month.

This series, it will be remembered, commenced in the May issue, and as they are of considerable importance we advise all students interested in the subject to give them due attention. Never was there a time when wireless knowledge could be more usefully employed. The nation

has need of all her wireless operators, and those who can obtain a Certificate of Proficiency in the subject become of immense value to the State, not necessarily as a active community but certainly as a reserve force on whom she can rely if need be. It has been the aim of the Marconi Company to give every encouragement to enthusiastic students, and with this end in view they, last year, arranged competitive examinations in wireless telegraphy, and, as a further encouragement, offered prizes to the most

efficient. The response they received was so gratifying that they determined to renew their offer, and an announcement to this effect was made in the August number of *THE WIRELESS WORLD*. All who are anxious to avail themselves of this offer are advised to read carefully through this announcement. They will find that the competitions are open not only to the former groups of competitors, but also to members of recognised wireless societies, clubs or associations, and to Colonial boy scouts. Already we have received appreciations of this announcement, and the keenness evinced is a credit to the manhood and youth of Great Britain.



The Wireless Apparatus at Greenwich Observatory.

Farmers and Wireless.

A Scheme to Banish Isolation.

FARMERS residing in the isolated districts of Australia have long been handicapped by the lack of means of swift communication with the outside world. Far from towns, they are often compelled to put up with inconvenient and sometimes dangerous delay in the satisfying of wants or necessities. An interesting suggestion for a remedy for this state of affairs has been made by Mr. W. King Witt, vice-president of the Wireless Institute of Victoria. Mr. Witt, during a recent tour in central Gippsland, was impressed by the isolation of the farmers, and he points out that the terrors and disadvantages of loneliness might be greatly reduced by the use of wireless telegraphy.

The establishment of such a system, linking up the scattered homesteads of the country, would certainly be a boon to the farmers. Cut off as they are, a crisis such as may be caused by sudden illness finds them helpless, and in those cases where medical help is wanted urgently, and life is ebbing away, precious time must often be taken up by weary journeys to the nearest township or the nearest telegraph station. A means of communication would do away with the pain and anxiety of a dusty, frantic gallop for help. It would halve the time of waiting, and double, perhaps, a sufferer's chance of life. For ordinary purposes, too, wireless telegraphy could prove of the greatest assistance to the agriculturist. Moments arrive when farming requisites are in urgent demand—spare parts for broken machines, perhaps; or perhaps the housewife would like a fresh supply of some domestic requirement in the shortest possible time. At present a weary journey may have to be faced in order to give the order, and time is necessarily wasted. Farmers themselves realise this keenly, and there has been in some districts a strenuous demand for the installation of a telephone system providing speedy communication with the nearest town. But it has been pointed out by the Postmaster-General that the idea is im-

practicable, on account both of the difficulty and expense of erection and of the negligible revenue that would accrue.

A cheap and practical substitute, then, is provided by a wireless telegraphy system run upon the lines suggested by Mr. Witt in the *Melbourne Age*. Persons requiring the service would organise themselves into a co-operative body, subscribing to a fund which would provide a wireless station for each member and a central station at the nearest town, where an operator would be on duty. The extra cost of the erection of mast, aerial, and assembling of instruments would depend upon the ability of the erector, and it is suggested that a trained operator might be employed at the commencement to get things into working order. The matter of supply could be dealt with by having at the central station a small plant for charging accumulators. The participants in the scheme would then have to learn to use the telegraph. That done, the farmer, or one of his employees, would be in a position instantly to communicate, through the wireless chain, with the nearest town and the central station. Mr. Witt suggests that the Postmaster-General might be asked to license stations operating under this scheme under the same conditions as experimental stations. It would save the country trouble and expense, and it would be a blessing to the isolated inhabitants.

In illness or emergency of any description it would only be necessary for the farmer to seat himself at his instrument and tap out with the key before him his cry for help or his order for a new cultivator. From the transmitter the waves would flash like ripples in the ether, to be gathered in by the cobweb of wires at the central station; and in half the time that would ordinarily be taken help would be at hand, or the new machine on the road. And, maybe, in the evenings the wireless would crackle busily with private gossip or invitations from one to another to "come round and see us." Thus would loneliness be banished.

Aerials and their Radiation Waveforms. VII.

By H. M. DOWSETT.

PLAIN AERIAL.—Plain aerial is a term known and used for many years by English-speaking wireless engineers and operators and by many foreign engineers to denote the setting up of radiation oscillations in an aerial by directly charging it as a condenser, and discharging it to earth by means of a spark.

It is used in the "International Radiotelegraphic Convention," 1912, and in the British Post Office "Handbook for Wireless Telegraph Operators," yet it has not found its way into any leading text book.

Plain aerial transmission came into being on the first occasion Commendatore Marconi used a vertical wire as radiator attached to one side of his spark discharger, and earthed the other side. It has since played a tre-

mendous part in the development of wireless. Yet its method of operation has been little understood. Text book diagrams of radiation from an aerial having a spark gap in it usually show tuned wave radiation, not plain aerial.*

The author's conception of plain aerial is developed and illustrated herewith.

Fig. 1 shows a vertical section through the field of electric strain on an aerial having a static charge, the sense of the strain being indicated by arrow heads. The broken lines starting from the aerial indicate the strain lines which start in the plane of the

section, but bend round and reach the earth outside the section. The aerial is separated from earth by a spark gap—not shown. Its capacity is supposed to be negligible. This simplifies the construction of the diagrams to follow, without affecting the general results. Now it has long been recognised in alternating current work that a wave form which has not a true sine wave character—which is, for instance, humped or square—can be resolved into several component harmonic waves, each of them a true sine wave. Then suppose we consider the static charged aerial at the moment of its discharge from this standpoint.

The potential in the aerial has a square wave-form. Then every part of the aerial—as the effect of the discharge travels upwards—can be considered as the seat of the

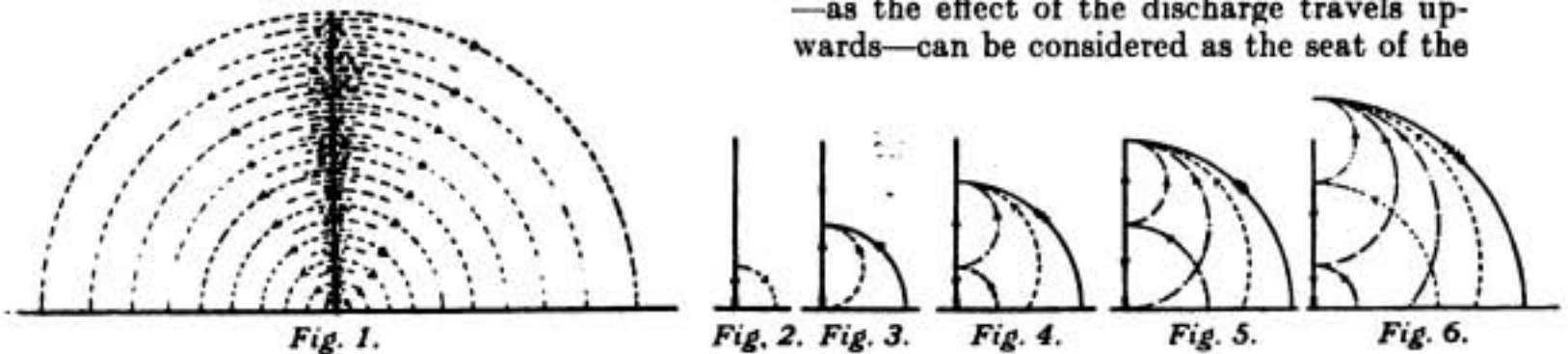

antinode of a wave which is set free at the instant the potential at that place commences to fall. There is no limitation of the waves set free to the harmonics of the natural period of the aerial, for, during the discharge, at every point of the aerial there is an instant when there is no current flow, while at the same instant current is flowing at the spark gap. Figs. 2 to 10 illustrate the development of the discharge in general, the radiation from one side only of the aerial being shown, omitting for the moment the consideration of that part of the discharge which leaves the aerial as harmonics.

In Fig. 2 the discharge has travelled up one-quarter the length of the aerial, and is setting free a wave of the natural period of

* J. A. Fleming, "The Principles of Electric Wave Telegraphy and Telephony," 1910, p. 408, Figs. 22 and 23. G. W. Pierce, "Principles of Wireless Telegraphy," 1910, p. 124, Fig. 90.

this length of aerial. At the same instant the field of electric strain between aerial and earth and above this wave is identical with the field shown in Fig. 1, but it is omitted in Fig. 2 and the diagrams which follow to simplify them.

In Fig. 3 the discharge is just being felt half-way up the aerial. But the front of the wave set free one-quarter the way up has expanded outwards and upwards, and has kept pace with the discharge impulse,

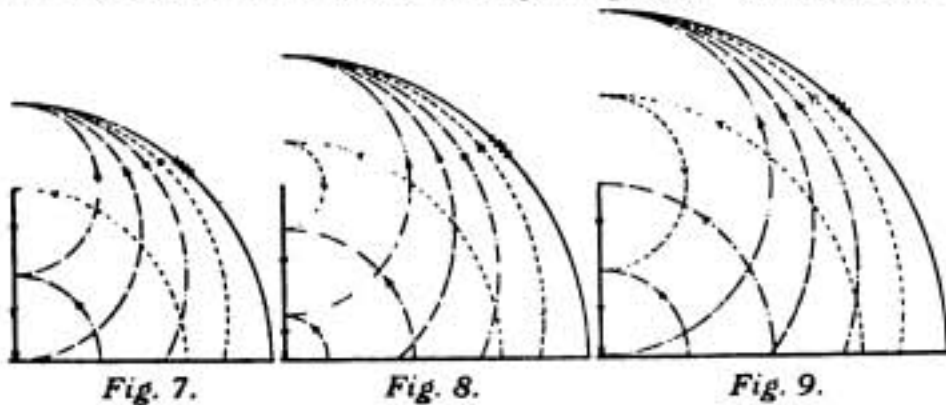

so that at the instant the wave is set free from half the aerial its front coincides with that from one-quarter the aerial. This is indicated by the two arrows on the wave-front. The potential, therefore, of the wave front increases as the discharge proceeds.

Fig. 4 in a similar manner shows the discharge impulse at a point three-quarters up the aerial, where it is setting free a wave corresponding to that length, which in its turn has its front superposed by the quarter and half aerial waves—indicated by the three arrow heads—the potential being correspondingly augmented. But a new feature makes its appearance in Fig. 4. The reflex of the first quarter aerial wave set free has now charged the aerial in the reverse sense, one-quarter the way up. What is it to do next? There is nothing to stop the charging current from proceeding further, no reflected wave of the same period returning down the aerial to assist in creating a standing quarter-aerial wave. The charging current of the reflex quarter wave, therefore, does proceed further, and as shown in Figs. 5, 6, 7 and 8, it is not stopped until it reaches the top of the aerial, its tendency to break away with its original frequency, however, checked, as the aerial cannot resonate to its period. From there in due time it returns, and therefore it degenerates from a wave whose length is

determined by quarter the length of the aerial to a wave determined by the whole length of the aerial—the fundamental—and this degenerate wave lags 45° behind the first fundamental wave sent off by the aerial.

But this is anticipating the development shown in the diagrams. Let us go back to Fig. 5. Fig. 5 shows the field of electric strain at the instant the discharge impulse reaches the top of the aerial—when it sets free the fundamental, with its wave-front superposed by the wave-front of the quarter, half and three-quarter aerial waves which accompanied and kept pace with the discharge impulse. It shows also the wave-backs of the quarter aerial wave, half aerial wave and three-quarter aerial wave in different stages of freedom expanding from the aerial. And lastly the further expansion of the quarter aerial reflex wave which is changing its wave length.

Fig. 7 is of interest, as it shows this reflex wave at the instant it is leaving the aerial as a fundamental wave.

Fig. 9 shows the first fundamental at the

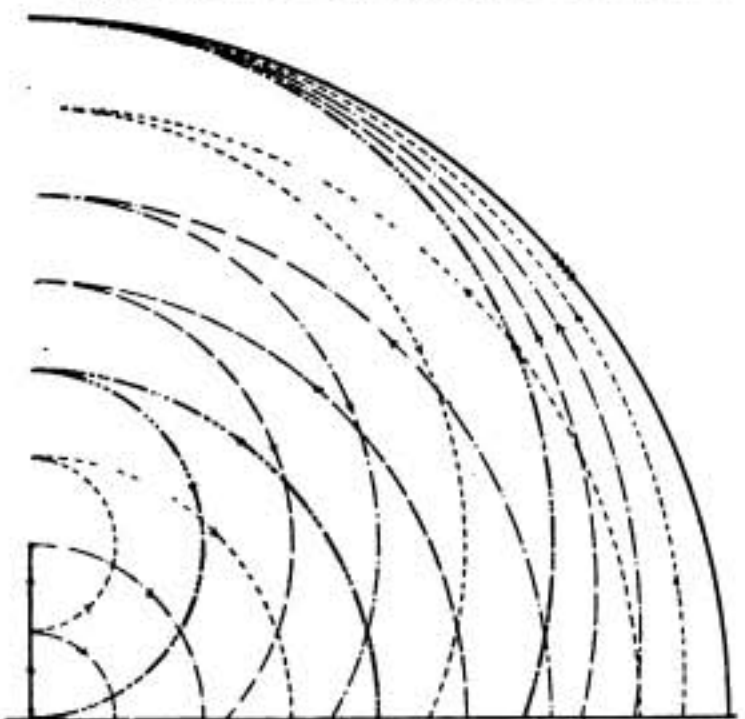

Fig. 10.

instant it is clear of the aerial, comprising within its period waves of all other shorter periods—for the quarter, half and three-quarter aerial waves whose generation has been described, were taken as representative

of waves set free from every length of the aerial measured from the spark gap.

And following this first fundamental—seen more clearly in Fig. 10—is a succession of other much weaker fundamentals, the reflexes of the shorter-period waves, out of

Typical harmonic radiation is shown in Figs. 12 and 13. Fig. 12 gives the expansion of the wave of triple frequency, and Fig. 13 the expansion of the wave of five times the frequency.

When a wave is set free from one-third

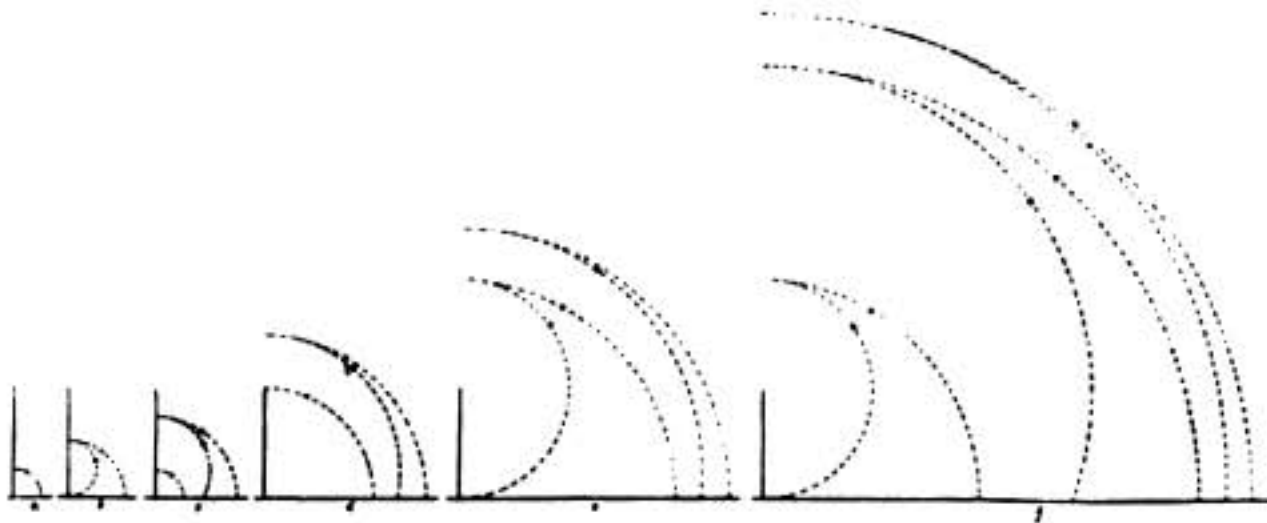

Fig. 11.

step with each other and the main fundamental. For convenience of reference the original fundamental wave with its reflex has been lined in heavier than the rest, and every original wave has been given the same type of broken line as its own reflex.

The development of the radiation of any

the length of the aerial, Fig. 12 (a), the first stage of its expansion does not differ from the first stage of every other wave, Fig. 12 (b). Its reflex also does not stop at one-third the length up the aerial, Fig. 12 (c), but flows up higher without breaking away. When however, it reaches the top of the aerial,

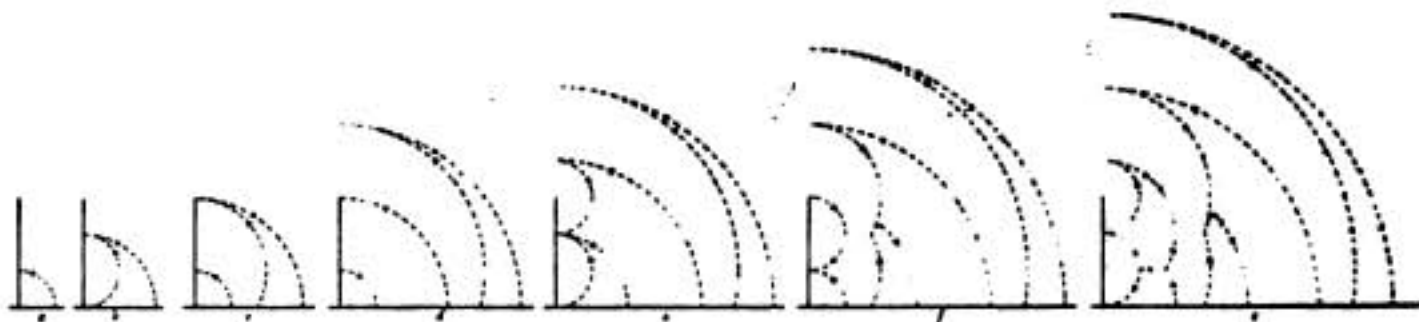

Fig. 12.

single wave which is not a harmonic of the aerial is shown clearly in Fig. 11.

But what of the harmonics? As the aerial when sparking is earthed, the harmonics will consist of all frequencies which are odd multiples of the fundamental, frequencies of three, five, seven times, etc.

Fig. 12 (d), and can go no further, another wave has at that instant reached one-third the way up, and its antinode therefore occurs at the same position in the aerial as did the antinode of the original wave at the moment it broke away.

Further progress up the aerial being



Fig. 13.

stopped at the same instant for all wave energy in the aerial, there is a simultaneous break away into space of the wave from both antinodes, ending at the position of the wave nodes. This is shown in Fig. 12 (e). The whole aerial thus being set oscillating to a harmonic, continues to oscillate, the

following reflexes are harmonic groups which are part earth bound and part free waves.

The behaviour of such free waves has already been fully discussed.*

What are the relative strengths of the waves sent off by plain aerial, and what is

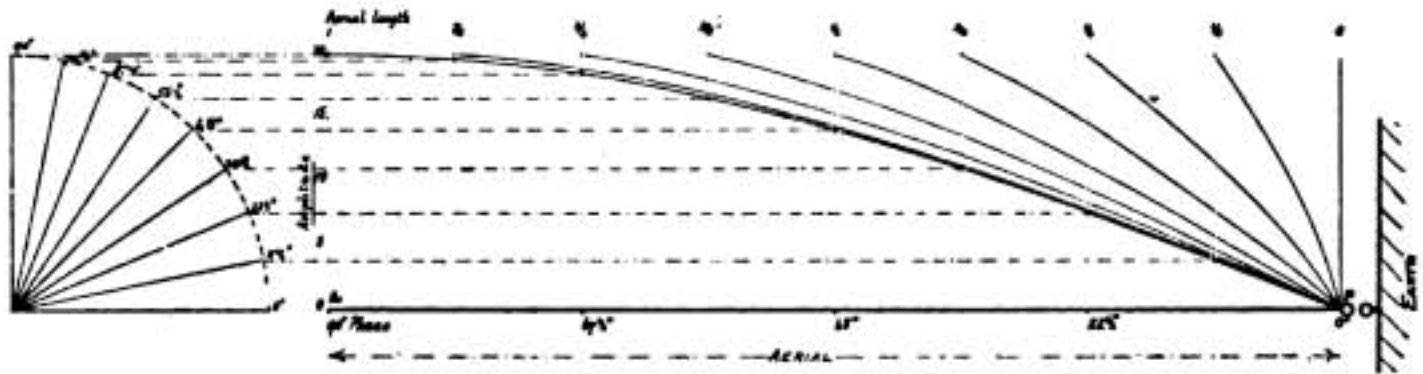

Fig. 14.

top part of the aerial with its own energy, and the bottom part with its own energy—there is no flow as in the previous operation of wave energy from the bottom to the top of the aerial. The growth of the new double wave which results is shown in Fig. 12 (f), and Fig. 12 (g) shows it getting away into space.

the final character of their resultant travelling along the earth's surface?

Let P L, Fig. 14, represent the aerial, charged to a potential of, say, 20 units.

Draw the potential sine curve of the fundamental oscillation, P1, by means of a quadrant of radius 20, Fig. 14a, projecting the sines of the various angles obtained

All remaining waves in the same wave train will have this new character. Fig. 13 (h), for instance, shows the radiation of two double waves of the type last described. the harmonic in this case having five times the frequency of the fundamental.

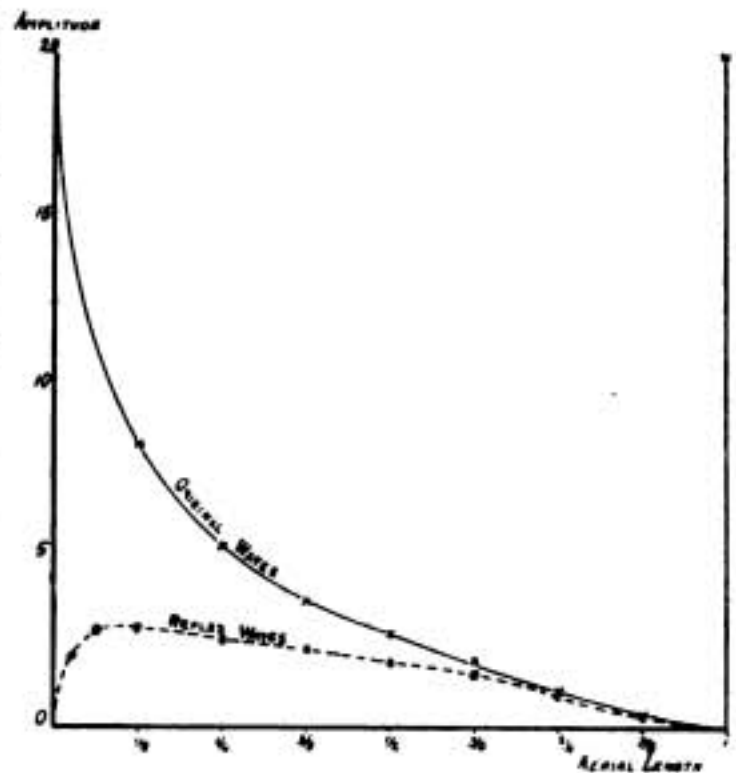

Fig. 15.

Then to complete Fig. 10 one must imagine the wave trains of the harmonics to be superposed on the wave trains shown. This has not been done for the sake of clearness.

therefrom, to their corresponding phase positions on the aerial, P L, and joining up the points so found.

A general description of plain aerial radiation may be given as follows :

Now the potential on the aerial before

(1) The first fundamental wave radiated comprises within its period earth-bound waves of all periods up to that of the fundamental.

(2) The wavefront of the first fundamental is superposed by the wavefronts of all other waves set free by the aerial, whether harmonics or not, and its potential is considerably increased thereby.

(3) The reflex waves which follow, except those due to harmonics, are all earth-bound fundamental waves, out of phase with the main fundamental.

(4) The first reflex waves of harmonics are earth-bound harmonics, the second and

* THE WIRELESS WORLD, October, p. 421.

discharge is the same at all points—20 units. But at seven-eighths the aerial length, the sine curve of the fundamental is 0.4 units less than 20. Then 0.4 units must be the amplitude of the bunch of waves of which the seven-eighths aerial wave is a

which has the same potential as the fundamental. The values thus obtained are the amplitudes shown in the first part of the potential wave curve, Fig. 16, reading from the right. The calculated check values are given in Table I.



Fig. 16.

mean. Draw in the sine curve, $\frac{7}{8} P$, adding this additional amplitude to the fundamental.

At three-quarters the aerial length the sum of these amplitudes is 1.11 below 20. Then the amplitude of the waves of which the three-quarter aerial wave is the mean must be 1.11 units. Draw in the sine curve, $\frac{3}{4} P$, adding this additional amplitude to that of the fundamental, and seven-eighths aerial waves, and find as before by what amount the resultant at five-eighths the aerial length is less than 20 units.

If this process is continued until the foot of the aerial is reached we arrive at the result shown in the full line curve, Fig. 15.

This curve shows that *the shorter the waves sent off by plain aerial compared with fundamental, the greater their amplitude, the maximum amplitude being obtained from the minimum wave leaving the foot of the aerial*

The minimum wave and the maximum wave—P1, the fundamental—have the same amplitude, and their fronts coincide. The wave, P $\frac{1}{8}$, has an amplitude of 8.42 units, and its front coincides with P1. The wave, P $\frac{1}{4}$, has an amplitude of 5.34, and its front also coincides with P1, and so on with all the waves.

The first half oscillation along the earth completed—corresponding to a complete wave in space—the periods of all the waves with the exception of the harmonics change to that of the fundamental in the manner already described.

If it is assumed that no energy is lost in the first half oscillation, the second half oscillation at the new period will contain an equal amount of wave energy, but it will now be spread over the whole aerial instead of only part of it.

This will result in the maximum potential of the new period wave being lower than that of the old period wave.

Let K_1 = capacity of $\frac{1}{8}$ th aerial length, generating one of the original waves,

V_1 = maximum potential of original wave,

K_1 = capacity of the whole of the aerial,

and V_1 = maximum potential of reflex wave.

$$\text{Then } V_1 = V_1 \sqrt{\frac{K_1}{K_1}}$$

TABLE I.

Length of aerial oscillating.	Phase of wave.	Amplitude.	Phase of wave.	Amplitude.	Phase of wave.	Amplitude.	Phase of wave.	Amplitude.	Phase of wave.	Amplitude.	Phase of wave.	Amplitude.	Phase of wave.	Amplitude.	Phase of wave.	Amplitude.
1	90°	20	—	—	—	—	—	—	—	—	—	—	—	—	—	—
0	78.75°	19.6	90°	.4	—	—	—	—	—	—	—	—	—	—	—	—
	67.5°	18.5	77.2°	.39	90°	1.11	—	—	—	—	—	—	—	—	—	—
	56.25°	16.6	64.3°	.36	75°	1.07	90°	1.97	—	—	—	—	—	—	—	—
	45°	14.1	51.5°	.312	60°	0.96	72°	1.87	90°	2.76	—	—	—	—	—	—
	33.75°	11.1	38.6°	0.249	45°	0.785	54°	1.59	67.5°	2.55	90°	3.73	—	—	—	—
	22.5°	7.6	25.7°	0.173	30°	0.555	36°	1.16	45°	1.95	60°	3.23	90°	5.34	—	—
	11.25°	3.9	12.9°	0.089	15°	0.287	18°	0.61	22.5°	1.06	30°	1.86	45°	3.78	90°	8.42
	0°	0	0°	0	0°	0	0°	0	0°	0	0°	0	0°	0	0°	0

The ratio of the capacities in this formula is the same as the ratio of the aerial lengths generating the two waves; the values of V_1 corresponding to the original waves P_1, P_2 , etc., can therefore be easily obtained.

They are given in Table II. and in the dotted line curve Fig. 15, and again in Fig. 16, being the values of the maximum amplitudes in the second and succeeding half oscillations reading from the right.

This accounts for the greater part of the energy radiated by plain aerial. The small part due to harmonic radiation can be treated in exactly the same way. The strength of each initial wave can be obtained from the full line curve, Fig. 15, as before. The energy of the reflex wave distributes itself over the whole of the aerial instead of only over the original part, and therefore the maximum potential is reduced correspondingly, and can be obtained from the formula

$$V_1 = V_x \sqrt{\frac{K_x}{K_1}}$$

The sum of the wave potentials in Fig. 16 is given in the plain curve, Fig. 17. The harmonics will cause the plain curve to be rippled. The effect of the harmonics of three and five times the fundamental frequency is shown dotted.

Finally, the tops of this resultant curve along the earth's surface suffer the usual

mutilation due to earth absorption of the backs of the waves.†

The potential curve in space above the earth's surface requires special treatment owing to the existence of the free harmonic waves. As, however, the harmonics are comparatively weak, they can only affect the main result to a small extent. Speaking generally, the potential measured to any base line originating on the aerial, but extending into space above the earth, will be similar to Fig. 14 but flatter, and the

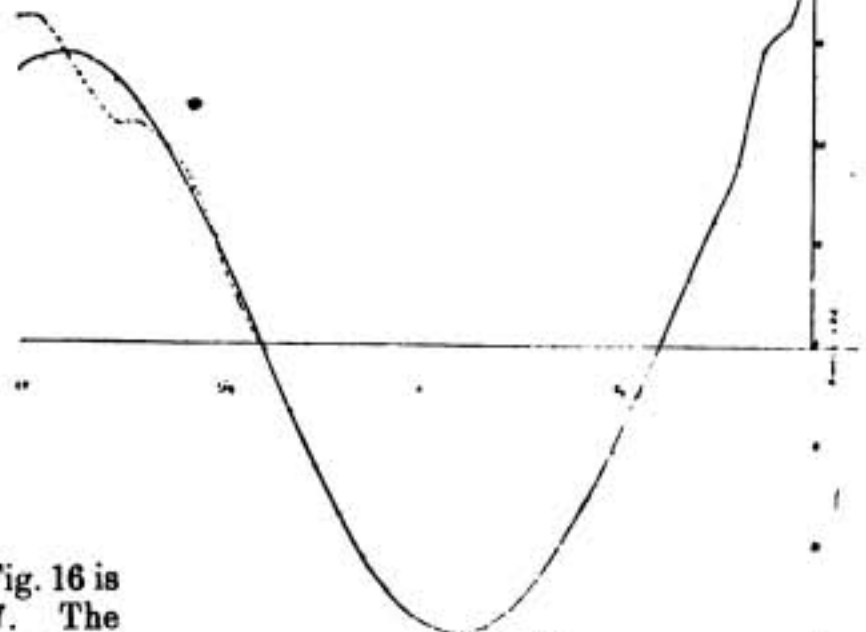

Fig. 17.

ripples due to harmonics will be more distinct or less distinct than on the earth according to the elevation and gradient of the base line.

† THE WIRELESS WORLD, June, 1914, p. 151; August, 1914, p. 223.

TABLE 2.

Length of aerial generating original wave.	Length of aerial generating reflex wave.	Amplitude original wave.	Amplitude reflex wave.
K_x	K_1	V_x	$V_1 = V_x \frac{K_x}{K_1}$
1	1	20.0	20.0
1/2	1	0.4	0.37
1/3	1	1.11	0.96
1/4	1	1.97	1.56
1/5	1	2.76	1.95
1/6	1	3.73	2.28
1/7	1	5.34	2.67
1/8	1	8.42	2.98
1/16	1	11.5	2.87
1/40	1	14.7	2.10

The

ENGINEERS

Note Book



[Under this heading we propose to publish each month communications from our readers dealing with general engineering matters of various kinds in their application to wireless telegraphy, and we would welcome criticisms, remarks and questions relating to the matter published under this heading. We do not hold ourselves responsible for the opinions and statements of our contributors.]

The Care and Operation of Diesel Oil Engines.

IT is not intended in this article to go into the theoretical side of Diesel engines, that part being well attended to by designers and engine builders. The following remarks are intended primarily for men in charge of stations where these engines are installed.

The main advantage of Diesel engines over other oil engines is the fact that most crude oils can be burnt in them without having to undergo any refining process. The action of the engine is as follows: Air is drawn in on the down stroke and is compressed on the up stroke. At the top of the stroke the fuel is blown in by compressed air at a pressure of about 900 lbs. per sq. in. The air having already been compressed to a pressure of about 800 lbs. per sq. in., is at a temperature sufficiently high to vaporise the blown-in fuel and the gas thus formed burns steadily on the down stroke. The exhaust takes place in the ordinary way, thus completing the cycle of operations.

The engine is started up by means of compressed air, which is sent out with the engine in steel bottles. Since the amount of air sent out with each engine is limited (probably sufficient to start up the engine twice), it is essential that the engine should run for at least twenty minutes the first time it is started up, or long enough to pump up the starting bottles with compressed air.

The following remarks may help to reduce the non-starting factors to a minimum. In the first place, of course, all bearings should be attended to. Although the engine will be working on crude oil in the ordinary way, it

is best when first starting up to use paraffin, especially in cold climates. This at once does away with the chance of the fuel not reaching the injection valve, and hence the engine gets fuel on the first, or at least on the second, working stroke. Also the paraffin is more easily vaporised than crude oil. The last point where the fuel can be observed to be running freely is at the distribution box. This should be flooded and the oil run through to get rid of any possible air locks.

Care should be taken to see that all joints are screwed up tight on the pipes connecting the starting bottles with the engine; otherwise, the engine may fail to start, as all the air that the bottle can supply is required during the first few strokes of the engine.

The first thing to do after the engine is started up and running well is to pump up the starting bottles to a pressure of at least 600 lbs. per sq. in., thereby providing air in case the engine has to be shut down quickly should it run hot or any mechanical trouble develop. This precaution has often been overlooked, with the result that if the plant is situated in a place where transport is difficult it has not been possible to start up the engine again for a long period. If for any reason the engine fails to start after the first fifteen revolutions, the air supply from the starting bottle should be shut off at once, thus leaving sufficient pressure in the bottle to make a fresh start. If the plant is situated in a cold climate, the circulating water should be shut off during the starting period, care being taken, however, that the cylinder jackets are completely full of water. Once the engine is under way the cooling water should be flowing at such a rate as to discharge at the outlet pipe at the proper temperature. The actual rate of flow, of course, depends upon

the initial temperature and upon the load the engine is taking.

Providing the engine is running well, crude oil should be substituted for the paraffin which was first used to start up, at the same time increasing the injection pressure. This increase of pressure is necessary, as the crude oil is more difficult to split up than the paraffin.

General Method of Starting Up.

The operations should be carried out in the following order :—

(1) Note that the cam levers are in the proper starting position.

(2) Flood the distribution box. It is *always* well to start up on paraffin if practicable. See that the distribution box valve is in the right position.

(3) Release the exhaust valve levers and make sure that the valves lift properly, using the bar provided for that purpose. Should it be found that they are sticking at all, lubricate with paraffin and *not* oil.

(4) Set the regulator in the starting position, care being taken not to mistake the full load position for this. In the full load position the engine will not get sufficient oil for starting.

(5) Open all oilers and circulating valves. On large engines the oilers should be opened at least fifteen minutes before starting.

(6) Note particularly if the governor is screwed down, in order that it may have no effect on the oil supply at the commencement.

(7) Blow off any water which may be in the air vessels.

(8) Open the middle valve on the bottle supplying air for the injection of the fuel. The pressure in this bottle should be at least 600 lbs. per sq. in. Should this pressure happen to be down, it must be raised by connecting the bottle to one of the starting bottles.

(9) Connect up the running bottle with the starting bottle by opening the right and left hand valves. This operation should be carried out as quickly as possible.

(10) Open the starting valve, and after the engine flywheel has made about eight revolutions, put the cam levers in the running position. As soon as the engine fires shut the starting valve and put the oil regulator in the "no load" position. *At once* note the speed of the engine and regulate accordingly on the governor.

(11) Open the air regulators on the compressors and pump up the air bottles to about 950 lbs. per sq. in. When this pressure is reached the regulators should be closed so that only a sufficient supply of air is obtained to keep up the pressure in the running bottle. After this the starting bottles should be disconnected from the pumps and blown down to 900 lbs. per sq. in. in order to get rid of condensed water.

If the engine is not to be put on full load right away the cam levers should be put in the second notch. Do not forget to regulate the cooling water so that the outlet temperature is about 140 degrees Fahrenheit. Particularly note that the oil supply to the high pressure side of the compressors is running. The remedy for a smoky exhaust is found in the regulation of the injection pressure.

Running of the Engine.

The injection pressure should be adjusted according to the load, and when making this adjustment the exhaust should be noted, the best results being obtained when the exhaust is quite clear.

The injection pressure varies from about 600 lbs. per sq. in. at light load to about 900 lbs. per sq. in. at full load.

The exhaust valves should be lubricated with paraffin about every hour, one or two drops being quite sufficient.

The cooling water should be carefully watched during the first half hour's run and adjusted as the engine warms up.

When shutting down, the following points require attention :—

(1) Note if the pressure in the starting bottles is well up and the water blown off.

(2) Be careful not to close the valve which supplies air to the running bottle until the engine has come to rest.

(3) As the engine slows down the catches should be put up so that the exhaust valves are left open when the engine has stopped.

(4) Leave the flywheel in the position for starting—*i.e.*, with the crank just over the dead centre.

(5) Open the blow-off cocks on the air pumps and blow any out of the supply pipes.

The above is only offered as a help in the running of Diesel engines.

The makers' directions should, of course, always be followed, as the temperatures of the cooling water and the injection pressures vary with different makes. P. N.

The Pacific Wireless Chain.

Opening of the First Stations.

Notable Messages.

AN important link in the trans-Pacific wireless chain has been forged with the opening of the Marconi high-power wireless stations at San Francisco and Honolulu. This is an event of world-wide importance, signalling as it does a further advance in the commercial development of wireless telegraphy by bringing that means of communication within range of a considerably increased number of users of the world's telegraphs, to whom the reduction in cost which the wireless service makes possible (in addition to its other advantages) is a matter of no small moment.

The restrictions of censorship have had the effect of increasing the cost of cabling at a time when commercial communication by telegraph has been appreciably stimulated in the endeavour of British manufacturers and merchants to profit by the industrial collapse in continental Europe, and the facilities offered by wireless have, therefore, engaged very wide attention. Of the Marconi trans-Atlantic service, which has been in successful operation for many years, it is only necessary to point to the relief which it is able to offer business firms suddenly confronted with increased telegraphic expenditure, by effecting a saving of 33½ per cent. of their cable bill, the rate being 8d. per word as compared with 1s. per word by cable.

It should be mentioned that the Marconi Atlantic deferred night and week-end letter services to Canada and the United States have not at any time since the outbreak of war been suspended. Messages by any telegraph service are still subject to Government censorship and possible delay, but there is now no reason to believe that these conditions will to any appreciable extent affect the speedy transmission of messages "*Via Marconi*."

The new Pacific service inaugurated by the company will interest many business

firms in this country. The wireless rate from Great Britain is 2s. 3d. per word, representing a reduction of 9d. per word as compared with the existing rate *via* the cables. The beneficial effect of competition by the wireless company is, therefore, plainly evident. In order to take advantage of this new and cheapest means of communication, messages must be handed in at Marconi House, Strand, or if handed to the Post Office telegraph offices must be routed "*Via Marconi*," these two words being sent free of charge.

The new service will be described more fully in an early number of *THE WIRELESS WORLD*. It forms a link in a chain which will eventually reach from the United States of America to the Philippines and Japan. The Honolulu station stands on a broad stretch of land which slopes down towards the sea from the south-western base of the Koko crater, and in time it will serve as a relay for the transmission of messages from the Pacific coast of America to the Orient. The station is duplex, that at Koko Head being used for receiving, and at Kahuku, 50 miles distant, being used for transmitting. At Koko Head five masts, each 320 ft. high and 1,000 ft. apart in a straight line, carry the aerial used for communication with San Francisco; six other masts, each 450 ft. high and 1,000 ft. apart, are being erected for carrying the Yokohama aerial. The transmitting station at Kahuku has three steam-driven generators, each of 500 h.p., one for working to the Pacific Coast stations, one for working with Japan, and a third for emergency use. The latter may be used for working either way, both to the coast and to the Orient, and will be installed in such a manner that in case of a breakdown of the power apparatus the spare set may be quickly substituted, and thus prevent any delay in the handling of the traffic.

For working to San Francisco 32 aerials each about a mile in length are supported 300 ft. above the ground by means of a double row of masts, of which there are 12 in all. A similar arrangement of aerials of somewhat greater length, supported by 14 masts each 450 ft. high, will be used for working with Japan. The completion of the Marconi station on the Hawaiian Islands marks the beginning of a new era in wireless communication between the islands and the outside world.

The new service on September 24th was formally inaugurated, and it is appropriate that the first message by wireless from San Francisco to Honolulu should be from the President of the United States of America, which was addressed to the Governor of Hawaii and read as follows :

“ The White House, Sept. 24.

“ To the Governor of Hawaii :

“ May God bind the nations together in thought and purpose and lasting peace.

“ WOODROW WILSON.”

The next message was from the Secretary of the War Garrison to Major-General Wm. H. Carter, U.S.A., commanding the troops in Hawaii, who said :

“ I wish to extend my heartiest greetings to the people of Hawaii on this our first opportunity for direct communication by the most modern means.

“ This occasion merely serves to emphasize the close ties that will always bind the people of this country to our fellow-citizens in Hawaii, and I feel sure that it will result in further increasing the present well-deserved prosperity of that beautiful island.”

Then followed a message from Mr. Josephus Daniels, Secretary to the United States Navy :

“ Through the courtesy of the Marconi Company I have the pleasure of sending as my first communication over the new radio circuit between California and Hawaii my congratulations to the Governor and the people of Hawaii on the establishment of this new means of communication, which will promote our co-ordination of effort and unity of endeavour and bring the people of the territory into still closer relationship with their fellow-citizens on the mainland.”

To Dr. Montague Cook, Mr. Wm. C.

Redfield, Secretary of Commerce, telegraphed as follows :

“ Remembering pleasantly brief visit at your home fall 1910, permit me express my hope opening wireless telegraph with Honolulu will unite friends more closely and permit frequent renewals delightful meetings.”

The Governor of Hawaii, replying by wireless to President Wilson's message of the same day (September 24th) said :

“ With time and distance annihilated and space subdued through wireless triumphs and impulse the territory of Hawaii conveys its greetings, profound respect, and sympathy to Woodrow Wilson, President of the United States, as he so earnestly seeks the blessing of peace and good will for all men and all nations.

“ (Signed). L. E. PINKHAM.”

Greetings were also exchanged between the Mayors of San Francisco and Honolulu. The former, in reply to a greeting from the Mayor of Honolulu, said :

“ Your cordial message has been received by me in the operating room of the Marconi Wireless Company at Bolinas, and with me, a large delegation of San Franciscans. We are the guests to-day of the Marconi Company, witnessing the inauguration of their new wireless service with our neighbours in Hawaii. We send you hearty greetings, and join with you in wishing success to this new enterprise, which benefits us all. Aloha from San Francisco to Honolulu, to which I add my personal regard to you.

“ (Signed). JAMES ROLPH, JUN.,
“ Mayor.”

A party of prominent business men and others were shown over the San Francisco station, and after a close inspection of the plant and apparatus, the Mayor of the city, introduced to the company by Mr. R. P. Schwerin, Vice-President and General Manager of the Pacific Mail Steamship Company, in a brief speech referred to the advantages of the new Marconi service to the world at large and California and Honolulu in particular. He accorded a vote of thanks to the Marconi Wireless Telegraph Company of America and wished them success in their new undertaking.

CARTOON OF THE MONTH



Wireless Hints
How to clear an Aerial.

WAR NOTES.

By Our Special Irrespondent.

The Official Press Bureau takes no responsibility for the accuracy of the information given below.

*From the Front
and other Places,
October 28th.*

Considerable sparking is reported at the points of contact between the two armies.

One of the latest wounded to arrive from the front is an army telegraphist who stuck to his post six hours trying to send "Przemysl."

It is rumoured in Paris that the German spark will shortly be very effectively quenched.

Chorus of French field stations to German ditto: "You made us jamb you, and we didn't want to do it!"

I understand that the Kaiser has presented each of the wireless telegraphists employed in sending out the German official wireless news with a signed copy of Baron Munchausen's Tales.

The German General Staff has issued an order prohibiting the reception of any atmospherics apparently originating in British territory.

A considerable "liveliness" was recently evident in the North Sea when a bluejacket sat on the aerial lead-in during transmission.

And although the message sent was in code, the bluejacket's remarks were in very plain language.

The German imperial wireless chain now consists of a series of missing links.

And a station in Africa was the first ToGo.

From the Wolff Bureau and as a reason why Rheims Cathedral was bombarded, we are anxiously awaiting the statement that the cathedral was being used as a high-power wireless station.

But perhaps the Wolff Bureau fears it has called "wolf" too often.

A correspondent who shall be nameless (good job for him!) suggests that as the Germans are encouraging their troops with German bands, our regiments might well carry multiple tuners.

For which statement he has been awarded a torn copy of THE WIRELESS WORLD, for the feeblest joke of the war.

We see from the daily Press that a priest in Italy has invented a pocket wireless apparatus which can receive from long distances without an aerial. It is very comforting to think that even in war times this fortnightly invention can still be kept going merrily.

It is one of the disadvantages of a crystal detector that the explosion of a shrapnel shell within a few yards is liable to put it seriously out of adjustment.

The call letters of most German vessels begin with "D," and so do most of the names we call the German people.

The higher branches of wireless: Operating in a Zeppelin.

Reports from France indicate that the German officers are fond of raiding wine cellars and drinking champagne, which reminds us that the theory of damping has engaged attention in Germany for some years.

The closing by the Postmaster-General of amateur wireless stations necessitated by the war has resulted in several amusing contretemps. Thus, according to *St. Martin's-le-Grand*, one man who was reported to have a wireless aerial on his premises naively explained that of the wires alluded to, one was a clothes line, and the other had been erected as a perch for birds. A second suspected aerial proved, on investigation, to be a bundle of fishing rods with strings attached; and a third was found to be a flagstaff with wire guy-ropes. The owner of the last-mentioned erection gravely assured the Post Office that he was entirely ignorant of anything connected with electricity, but that if the wires attracted the electric currents and so obstructed in any way the working of the Government stations he would at once dismantle the staff.



NOTES OF THE MONTH

AN advertisement which appeared recently in a Scottish newspaper furnishes a striking illustration of the success of a new form of application of wireless telegraphy. This advertisement reads as follows:—

CLYDE LIGHTHOUSES' TRUST.
—
NOTICE TO MARINERS.
—
ROSENEATH PATCH BEACON.
—
UNATTENDED FOG GUN.

The TRUSTEES of the CLYDE LIGHTHOUSES HEREBY GIVE NOTICE that an AUTOMATIC FOG GUN, giving One Report every Twenty Seconds, HAS BEEN ESTABLISHED on this BEACON, and will be in OPERATION ON and AFTER the 2nd November, 1914, during Fog and Heavy Snow Showers. The Gun is unattended, and is actuated by Wireless Control from Gourock.

FORT MATILDA PIER.
—
UNATTENDED FOG GUN.

The TRUSTEES also HEREBY GIVE NOTICE that on the 2nd NOVEMBER, 1914, the present arrangement of FOG BELLS on the PIER will be DISCONTINUED, and will be SUPERSEDED by an AUTOMATIC FOG GUN, giving One Report every Ten Seconds during Fog and Heavy Snow Showers. The Gun is unattended, and is actuated by Wireless Control from Gourock.

By Order,
J. F. ANDERSON, Clerk.
137 St. Vincent Street,
Glasgow, 5th October, 1914.

Our readers will remember that in June last we published a full description of the apparatus used in the "wireless control" referred to in the above announcement, and we indicated some possible applications in addition to that which the Clyde Lighthouses' Trust have definitely adopted. Roseneath Patch, situated nearly in the middle of the Firth of Clyde, has one set erected on an isolated beacon and operated from the Coastguard Station at Gourock; Fort Matilda has another. By this action of the Clyde Lighthouses' Trust another very important step towards the safeguarding of

life at sea has been taken. Other sets will follow shortly, and so large a field is laid open for this particular application of the Marconi wireless control that the Marconi Company is busy designing sets suitable for greater distances.

* * *

Before sailing from Liverpool, Sir Ernest Shackleton explained to a *Liverpool Daily Post* representative that one of the objects of his expedition to the South Pole was to establish a wireless station on the Antarctic continent, and put a man in charge who could be relieved, say, once a year. Provisions and clothing and all the necessaries of life would, of course, said Sir Ernest, "have to be stored at the outpost, and if the plan succeeds we shall have established permanent human occupation under the British flag on the Antarctic continent. By this means part of the scientific work we are setting out to accomplish will have a direct bearing on commercial possibilities, and will have an indirect effect, at any rate, on the trade of Liverpool."

* * *

The rainfall in parts of Chili and the Argentine, if there is a heavy season, depends on the ice formation in the Weddell Sea—that is, if the ice breaks up early there is a light rainfall in parts of Chili and the Argentine; if there is a heavy ice season, it means a heavy rainfall in those areas. To be able to ascertain whether the rainfall is to be light or heavy must be of very great value to the farmers and stockbreeders of South America, upon whom the British nation relies so largely now for its meat supplies. The importance of such information has already been recognised by the establishment of a wireless station in the South Orkneys, which is mainly used for the

purpose indicated, but our station would be much further south and would be able to give more correct forecasts of the weather to be expected three months ahead.

* * *

This has led Sir Ernest Shackleton to predict that "In due time, without doubt we shall found a wireless post in the Antarctic continent, which will send wireless weather reports to South America saying whether the ice is likely to form heavily or lightly. In this way farmers and stock-breeders will be able more or less accurately to gauge the amount of rain that may be expected, and will know whether to conserve water or not. This will enable them to guard in some measure against the dangers of drought, and will facilitate the work of stock-raising. As Liverpool does a big trade in the importation of frozen meat it is likely that the establishment of the wireless outpost in the Antarctic will have some bearing on the port's industry."

* * *

The temporary dismantling of all amateur wireless installations has put an end for the time being to the extensive practice of receiving wireless time signals. Profiting by the occasion, a correspondent (who is associated with an electric clock company) writes to a contemporary lamenting the fact that other clockmakers did not follow his example in leaving the new movement severely alone. Fortunately for the clockmaking trade there is evidently much more enterprise on the part of its members than appears to be possessed by the clockmaker, whose habit of mind (to judge from his letter) is so manifestly self-restrained that he would not allow himself to be manœuvred into a business offering wide possibilities. He writes:—

Some little time ago there was an attempt to persuade the clockmaking trade to purchase cheap wireless receiving apparatus, the ostensible reason being the advantage of obtaining a time signal without paying for it.

At that time we took no part in this movement, and to all clockmakers who wrote to us for information we replied pointing out that the wisest and safest

way of obtaining correct time is to subscribe to the British Post Office official mean time distributing system. The annual fees are small and the service is reliable. Those firms who followed our advice are to-day enjoying just as regular a service of time as they were before the war, whilst those who invested in wireless sets have had to dismantle their apparatus; and, in the opinion of many serious thinking people, it is very doubtful whether the Government will ever again permit irresponsible private individuals to possess apparatus so capable of being put to wrong purposes as wireless transmitting or receiving mechanisms.

It is, however, perhaps possible that the war itself has put an end to much of the sale of the cheap forms of wireless apparatus by the simple fact that importations from Germany are now ended!

The "facts" in the above letter do not inspire confidence in the writer's "prophecy." If the Post Office service, which has been available for many years, has satisfied all requirements, why has it not already been adopted by those who desire the wireless time service?

* * *

It is not generally known that the Morse alphabet in use in the United States and Canada differs from the "Continental Code" employed in Europe, although in their foreign telegraphic correspondence all countries are subject to the same international rules and regulations. That this lack of uniformity can be a serious disadvantage is evidenced by the following example which is quoted by the *Telegraph and Telephone Age* of New York. According to this several Canadian operators recently offered themselves for military service and to join the Canadian engineers on the battlefields of Europe. It was pointed out to them, however, that their lack of knowledge and practice of the Continental code would act as a bar to the attainment of their desires in the present instance. This is certainly a convincing argument in favour of a universal telegraphic code, towards the institution of which a commencement might be made by unifying the telegraph alphabets as practised in Great Britain and Canada.

Maritime Wireless Telegraphy

THE revenue cruiser *Margaret*, built to the order of the Canadian Customs Department by Messrs. John I. Thornycroft & Co., Ltd., Southampton, is designed for custom patrol service on the Atlantic Coast. Her length in all is 200 feet and between perpendiculars 185 feet. The vessel is largely intended for service in the vicinity of ice, and a double bottom is fitted under the engines and hold forward. The



The Canadian Customs Cruiser "Margaret."

hull is stiffened to resist ice and the shaft is housed in the hull for the whole of its length. The boat is completely fitted up; there is a wireless telegraphy outfit and an electrical installation which, in addition to furnishing general lighting and power for the wireless plant, supplies current for a 24-inch projection searchlight fitted in the crow's-nest on the fore mast.

* * *

The report of the Court of Inquiry concerning the loss of the s.s. *Columbian* has now been issued. It throws much light upon the circumstances attending the use of wireless at the time of the disaster, and explains why the distress signal was not received by another vessel in the vicinity. The *Columbian* was equipped with a Marconi standard 1½-kw. installation supplied with current from the ship's dynamos and having a daylight range of approximately 180 miles over water. The equipment also included a

Marconi standard emergency gear, having a capacity of at least ten hours' continuous transmission, with a daylight range of approximately 130 miles over water. It will be remembered that fire broke out on board the vessel, and the heavy explosion which followed quickly not only put the dynamo out of action, but partly wrecked the Marconi cabin and carried away the aerial. Only one message was sent before this accident put a stop to wireless transmission. This was a call to the *Winifredian*, a ship known to be in the vicinity of the *Columbian*. According to the recollection of Mr. Burke, the Marconi operator who sent it, it ran: "Here *Columbian* on fire. Come immediately." The message was received at Sable Island station, 200 miles away, as "Hurry up. Ship on fire." This message was not received by the *Winifredian*. In the printed judgment of the Court of Inquiry it is stated "from the very careful and exhaustive examination of their records by the Marconi Company, it would appear that at the identical moment the *Columbian* was calling for help, the *Winifredian* was engaged in a conversation with another ship, and never got the call. No one seems to blame for this unfortunate combination of circumstances.

* * *

Wireless brought timely assistance to the passengers and crew of the *Prince Albert*, which, on August 17th, went ashore on Butterworth Rocks while making the crossing from Queen Charlotte Islands to Prince Rupert. The Butterworth Rocks form a sharp escarpment jutting out from the coast of Columbia, and are at all times a source of grave danger to navigators; moreover, at the time of the *Prince Albert's* mishap a dense fog prevailed. No sooner had the vessel struck than the captain gave instructions for distress signals to be sent out. They were quickly responded to, and before very long several vessels were upon the scene, but they were powerless to do more than stand by as the force of the impact had driven the *Prince Albert* full on the topmost

ridge. Besides, the fog made navigation in such waters a task of the greatest peril, so that only when it lifted was it possible to do anything for the relief of the unfortunate passengers. These had, by the captain's orders, taken to the boats immediately after the collision, and as they were apparently without any sort of wireless equipment, they were unable to make their whereabouts known to their would-be rescuers.

It is in circumstances such as these that the advantages of an emergency wireless set for lifeboats, of a similar type to those fitted on the boats of the *Aquitania* and other ocean-going liners, are most evident.

In the case of the *Prince Albert* the absence of any means of communication was responsible for the fact that when the lifeboats were picked up many of the passengers were in a pitiable condition, owing to cold and exposure. Nevertheless they were saved, every one of them, and but for wireless on the *Prince Albert* so fortunate a conclusion to the disaster would not, under the con-

ditions prevailing at the time, have been possible.

* * *

The Texas Steamship Company's *Brabant* (call letters "KUU") has been admitted to American registry, and is now operated and controlled by the Marconi Wireless Telegraph Company of America. This vessel is engaged in the coastwise service, and applies a ship tax of 4c. per word, with a minimum charge for ten words.

* * *

The Eng Hok Fong Steamship Company's *Mexico City* (temporary call letters "MUK") has been equipped with Marconi apparatus, and is operated and controlled by the Marconi Wireless Telegraph Company of America, on behalf of the Marconi International Marine Communication Co., Ltd. This ship is in the Pacific trade, and applies a ship tax of 8c. per word.



The Interior of the Wireless Cabin, Canadian Customs Cruiser "Margaret."

Wireless Telegraphy in the War.

A résumé of the work which is being accomplished both on land and sea.

“WHEN the full story of the present European struggle on its gigantic scale comes to be written, I have no doubt it will be found that at critical moments wireless telegraphy has played an important part in the results, and that here, as elsewhere, it will be found that British naval and military officers . . . have established their superiority in its use over the enemy against whom they were engaged.”

The above passage, extracted from the concluding portion of an address on wireless telegraphy in war, which Prof. J. A. Fleming, F.R.S., delivered at University College, London, on October 14th, will, we believe, prove to have been a prediction not altogether unfulfilled. A detailed record of the progress of events concerning the utilisation of wireless telegraphy in the present naval and military operations cannot yet be attempted. The public can know little and see less of the application of this product of modern technique, the influence and bearing of which upon operations on land and sea are known only to the commanders of armies and battleships. Nevertheless, we are able to judge from the occasional newspaper references to wireless telegraphy that it is performing work of the highest importance. “Our capture of Togoland doesn’t affect the European war,” writes an officer who took part in the fighting in Togoland, “but,” he adds in his letter, an extract from which appeared in the *Times*, “the destruction of the wireless at Kamina might do, and that’s what pleased the Lords of the Admiralty so. For this destruction completely isolates the German South-West African colonies from Berlin.”

The isolation of the German colonies means curtailing the activities of the enemy’s commerce raiders, and this achievement constitutes a success for wireless telegraphy which must have some bearing upon the nature and duration of the war. The existence of vessels raiding some of the

highways of commerce is only possible when such vessels are able to keep in touch with wireless stations, and the enemy’s disability to make use of the latter will help to bring about the disappearance of a very disturbing factor.

The Humanitarian Aspect.

Modern war, and especially modern naval war, is presenting us with many new and strange situations to which it is necessary to adjust our ideas. The loss of the three British cruisers *Aboukir*, *Cressy*, and *Hogue* is an instance of this. While engaged on patrolling duty the *Aboukir* was sunk by one of the enemy’s submarines—an ordinary hazard of this duty. The *Hogue* and *Cressy*, however, were sunk because they proceeded to the assistance of their consort and remained with engines stopped endeavouring to save life, thus presenting an easy and certain target to further submarine attacks.

Here is a case where the heavy losses would have been avoided had only strict military considerations been adhered to. But the natural promptings of humanity still weigh with the sailor, and it is gratifying to find from a statement issued by the Admiralty that in future it will be possible to save life without prejudicing the naval or military situation. Disabled ships will be left as far as possible to their own resources, but, as the Admiralty statement points out, “small craft of all kinds should be directed by wireless to close the damaged ship with all speed.” Practically every class of naval vessel is now equipped with wireless, and this fact would show that it is possible to send out ships unaccompanied without placing them beyond the reach of help in case of a disaster. We have heard a great deal about the strategic influence of wireless in war; the Admiralty statement is a reminder that in a humanitarian sense wireless is no less useful.

This aspect of the use of wireless in war



H.M. King George V. and Queen Mary inspecting Motor-car Station supplied to the British War Office.



The Austrian Emperor inspecting a Military Wireless Station at Manœuvres.

is again brought to notice by an official announcement concerning Tsing-tau. The Japanese, who are besieging the fortress on land and blockading it from the sea, desiring to succour non-combatants and individuals of neutral Powers in Tsing-tau, communicated their wishes to the Governor. Wireless telegraphy was the means by which this communication was made on October 12th. Arrangements for a meeting were thereupon proposed and accepted; and the result was that three days later the American Consul and a certain number of Chinese subjects and German women and children were escorted to Tientsin.

News for Sailors.

We are all waiting for wireless to bring us news of further deeds at sea, but how many of us realise what wireless means to the men who are spending a tireless vigil, hoping to encounter the German fleet? A cheery, picturesque letter appeared in a newspaper from an able seaman serving with the North Sea fleet, in which the writer complained of inaction, owing to the German fleet remaining in hiding. He said:

"The authorities in this great fleet do all they can to entice the 'great' German fleet out, but no, they won't come. About a week ago our Admiral sent in a wireless to the German admiral: 'It's a nice day for a sail, sir,' but no, he wouldn't come. Everybody on board seems to do nothing else but talk of the one subject: will the Germans ever come out, or will they stick in and keep their ships to help pay the war indemnity?"

But the writer of that letter does not despair. "Perhaps," he added, "they will be forced to come out, and you may bet everybody on board this ship will cheer if the word goes round that a wireless has come aboard that the Germans have at last put to sea."

It is not to be supposed that our sailors are without news of the events in the various theatres of war. Every night the Marconi station at Poldhu transmits to ships at sea a summary of the day's events. These Press messages can be received by the vessels of the Grand Fleet, and the sailors are thus made acquainted with the daily progress of the war. On some of the vessels the news is circulated in the form of a daily sheet, and

one of these precious publications has been wafted ashore and reproduced in the columns of the *Morning Post*. It is a copy, dated September 12th, of the *Natal Newsletter* ("the unofficial organ of His Majesty's Ship *Natal*")—a chirpy little cyclostyle periodical of eight pages containing all the usual features.

It has a pictorial frontispiece based on the Bovril picture "Alas, my poor brother!" So that its meaning may be clear it is explained with some elaboration that "the Kaiser is represented as standing upon the safe side of the grocery department. He can give no more than sympathy to his poor, lone, bottled-off brother. The tear is caused by his own prospects. Rotten collection of ideas, isn't it? But that doesn't matter so long as we've got the German Emperor and the Fleet in. No respectable journal can go to press without them now." The back page is occupied by an advertisement which may be reproduced:—

Johnny Bull.

The Spirit of Nelson's Age,
Still Going Strong,
1805-1914.

The Tonic with a Healthy "Bight."
German Fleet
It bottled square,
Knocked the Kaiser
Everywhere.

To be obtained at the sign of
"The Iron Duke,"
or Harry Thuser and Co.

Among the comments and news items are the following:—

Water, water, everywhere, and not a ship to sink.

The Combination of "L" class destroyers and Heligoland seems to make a — of a mix up.

Press Bureau.

Germans in Paris.

Press Bureau (later).

Last message should read: "Germans in plaster of paris."

The doings of the Fleet for the past fortnight are a prohibited topic, so may not be discussed. In writing home it is best to say: "Dear Belinda,—Very busy this week. See last Thursday's papers."

The bewilderment of the Fleet at the news of the war ashore is represented in an article headed "Poldhu and Norddeich," the

British and German wireless telegraph stations through which the daily news bulletins are sent. It says:—

The daily Press messages are as like unto each other as the Harris sausage and its German kinsman. The component parts are theoretically similar, but mysteriously different. When Poldhu says the Umpteenth Army Corps got a good-sized dent in the front rank, Norddeich tells us that the Tiddley-Um-Pom Hussars added another glorious paragraph to "Willie's War Book." Both armies capture the same towns several times weekly. Just like "Beggar my Neighbour." Until everything is over and Conan Doyle has written a book about it we shan't know who has won.

P.S.—No news of the High Sea Fleet in either.

We envy the fine spirit of the men who, dwelling in the midst of such peril as our sailors do, are able to make the daily wireless Press messages the basis of a comic history of the war for the entertainment of their gallant comrades.

The Wireless Press.

But Poldhu has a more serious task to perform in the dissemination of accurate summaries of news for the enlightenment of those at sea and in neutral countries whose wireless stations are within the range of the station and stand by for the messages. Included in the nightly bulletins issued through the Marconi station is the copy of a message which the Foreign Office sends every night by wireless to His Majesty's representatives abroad. These messages are issued because of the demand in neutral countries to learn the truth about the war, which so far has been concealed by a world-wide news campaign organised by the enemy. Owing to the cutting of her cables, Germany is isolated telegraphically from nearly the whole of the world, and it is only through her wireless stations that she is able to communicate with the outside world and to disseminate her versions of the progress of the war. Thanks to the efficiency of the Marconi receiving instruments, all the messages issued through German wireless stations are received at the Marconi stations, and the public are able to enjoy daily examples of the news which the people in Germany are

permitted to read and with which that country seeks to impress the world. The frequent references to the Deity which were made in the earlier wireless messages have inspired "Evoe" in *Punch* to an "Ode to the Spirit of Wireless Victory." This ode is explained by the author as "an attempt, suggested by certain Marconigrams,* to shed further light on the nature of the principal Teutonic deity." We reproduce below some of the principal verses:—

What to thee are marching legions,
Cannon smoke and sabre thrust,
Goddess of the cloud-rimmed regions
In whose might the Germans trust?
Though, however high and regal,
Kingly pomp may break and bend
Soiled with murder (labelled legal),
Thou, more active than the eagle,
Thou endurest to the end.

Long e'er Paris heard the thunder,
Herald of the Uhlan's lance,
Thou wast making Stockholm wonder
At the dying flame of France:
Not on wires, with no word written,
Thou hadst trod thine airy track,
Faster than the mailed mitten,
And behold our fleet was smitten
Somewhere near the Skager Rack.

So. And when their lines are broken
When their shrapnel falls less fast,
Shalt thou fail to send a token
Undeclared to the last?
Surely not. Red devastation
Still shall urge by land and sea
Every proud advancing nation
While Marconi's installation*
Rules the skies of Germany.

Still when pagan peoples sever
Railway line and telegraph
Thou shalt keep thy staunch endeavour,
Thou shalt scatter us like chaff.
Still, O goddess of the Prussians,
Thou shalt sound thy trump of tin
Undeterred by rude concussions
While the Frenchmen hail the Russians
On the flagstones of Berlin.

EVOE, in *Punch*.

*[The use of this word and of the words "Marconi's installation" (in the verse) is misleading. "Marconigram" is a term frequently employed to designate commercial wireless telegrams. For reasons which are doubtless fully appreciated to-day, there are no Marconi stations in Germany, although in 1900 Marconi apparatus was installed on the Borkum Riff Lightship and Borkum Lighthouse.—Editor, WIRELESS WORLD.]



A German Military Wireless Balloon Section on the March.

Secrecy

There have been many instances of the interception of German messages since the commencement of the war, and lest there should be any doubt that secret British wireless communications can be overheard, or that our wireless service can be disrupted by means of interference or "jamming," we would quote the following extract from an article by Commander F. G. Loring, in the *Naval Annual*, which shows that tactics of this kind are by no means successful. The author's remarks on this subject are as follows :

"Interference caused by other stations, such as international interference of an enemy, is of far less importance than is generally supposed. It is an extremely difficult thing to seriously 'jam' a well-organised communication, and there are many ways, both technical and methodical, of defeating such an intention.

"A good deal of misapprehension exists in the minds of the public concerning this question of 'jamming.' It is to a large extent a question of degree.

"In the opinion of the writer, given good apparatus and a highly skilled personnel, it is absolutely impossible for an enemy to prevent a wireless message reaching its destination. It is not easy even to delay it for any considerable time.

"As an instance of the ineffectiveness of intentional jamming, I find in a report of the wireless communications of the 1906

Naval Manœuvres the following interesting paragraph : 'No serious interference was caused by intentional or unintentional jamming, though the enemy resorted to this for forty hours without ceasing.' In connection with this question of the possibility of effective jamming by an enemy, it must not be overlooked that by attempting it the enemy is certainly putting his own wireless communication completely out of action for the time being, while it is very doubtful if he is seriously inconveniencing the communications of his more distant opponent.

"The danger involved through the interception of a fleet's signals by an enemy is also, in my opinion, often overrated. Co-operation between operators, and full knowledge of each other's methods, is extremely important when handling difficult code messages, and the more skilled the organisation the more difficult it is for a strange operator to take down with the necessary accuracy the groups of a code message. He cannot ask for the repetition of doubtful groups, and he has no intimate and daily familiarity with the methods of his opponent to assist him in his task. And, after all, giving the enemy every advantage, giving him a perfect record of the signals, the key of the code to his hand, and equal facility of skill and language to translate it for use—a most improbable combination, it must be admitted—he has still failed to prevent the all-important information reaching its destination."



Marconi Cavalry Station working at Antwerp, Belgium.

At the Battle Front.

Striking examples of the enemy's inability to interfere with the regular operation of Marconi portable stations were furnished during the recent Balkan wars. For purely military purposes wireless telegraphy has four advantages over the older method of communication by wire, which makes its value in time of war almost incalculable. They are :

(1) Communication cannot be cut by the enemy, and there is no wire to be inadvertently broken by friendly troops.

(2) In case of a movement to a flank the communicating stations can be quickly moved without any wire having to be taken up and relaid.

(3) Communication can be established between two points without the necessity of having to traverse the country between the two points.

(4) Communication can be established with a ship at sea.

Secrecy is an important factor in military communication, and perhaps the surest method of obtaining this has been adopted by the Marconi Company in the design of their field stations.

This method is to change the wave-length of the transmitter at frequent intervals from one fixed wave-length to another. In the ordinary way the time taken to change the wave-length of a transmitter is a matter of some minutes, and to change the wave-

length of the receiver a matter of some seconds. But in the stations above referred to the different components of the syntonised circuits of both the transmitter and the receiver are brought to a three-position switch, called the "change-tune" switch, one such switch being fitted to the transmitter and one to the receiver. Each position of the switch changes the wave-lengths to a definite value, and the switch being operated by a single handle, the time taken to change the wave-length of either the transmitter or the receiver is thus reduced to a fraction of a second.

The operator can therefore change his wave-length or "tune" after every three or four words to any of the three waves to which his switch has been adjusted without waste of time and by sending a code letter, indicating to which "tune" he was about to change before each change. The operator at the station with which he is communicating, and whose receiver is similarly fitted with a switch, would be able to follow him without difficulty, whereas any other station would only be able to read at the most a few disjointed words here and there, which would be of little or no value in the hands of an enemy.

Of course, if such a station were always to work on the same three waves the enemy's station would soon measure the waves and devise a method of "standing-by" on all three waves; but the apparatus is so arranged that the value of each wave corre-

sponding to the different positions of the change-tune switch can be varied to anything between wide limits, so that each day, or even several times a day, the values of the three wave-lengths can be themselves changed.

If the wireless service of an army were properly organised with such stations as these, it would be a practical impossibility for any station, not informed, to read the messages transmitted.

Military Aviation.

There has been much activity displayed in the adaption of wireless telegraphy to aviation. The importance of this from a military standpoint is obvious, especially in the case of dirigibles which have a fairly long range of action. This range in recent airships amounts to several hundreds of miles, and consequently wireless apparatus of considerable power has to be installed to ensure sufficient communication between the ship and her base. The problem of adequate antennas is, of course, easily solved on a dirigible, the length of which is sufficient to provide plenty of room, and, indeed, there is no difficulty in getting a reasonable amount of power in the apparatus, because of the great carrying capacity of this type of airship. For obvious reasons not very much information can be given about the actual details of equipment as applied to military aircraft. There is no doubt, however, that light generating sets are in existence which are quite capable of sending wireless dispatches over long distances if not interfered with. A daylight working range of 200 km. is claimed for some of the German sets weighing scarcely over 50 lb. A greater range can be covered with apparatus of a weight easily transportable in an airship, and several times this range might conceivably be at times necessary.

In a military sense it is likely that most valuable scouting is being done at inconsiderable distances over which wireless conditions would remain fairly good. As to position finding with long horizontal receiving antennas, it should be possible to get considerable information from a properly organised system of sending stations. More interesting technically are the possibilities of wireless installations on aeroplanes. Material headway has been made, too, in this branch of the subject, but

the difficulty of carrying suitable antennas complicates the situation. Various methods of installing antennas have been tried, the favourite one appearing to be a trailing bronze wire carried clear of possible interference with the propellers. A range of sending and receiving distance in the neighbourhood of from 50 km. to 100 km. has been experimentally reached with equipment of practicable weight. It would be exceedingly interesting to know how far wireless communication has been tried on the present scene of hostilities; but the beautifully effective suppression of all ordinary sources of information leaves us quite in the dark as to the actual practice of aerial scouting in this respect. The time gained in sending home reports of observations by wireless telegraphy would evidently be worth something, let alone the possibility of receiving messages from airships which might be unable to get home.

In the Mercantile Marine.

How wireless is able to mitigate the disadvantages of the war to the mercantile marine is well brought out in an article which appeared in the *Nautical Magazine*, in the course of which there is an account of the escape of a British liner from the clutches of the German cruiser *Karlsruhe*, when off the Brazilian coast, homeward bound. This story is best told in the words of one who went through the experience. He says:

"I have just returned home after a voyage to South America in one of the Pacific Steam Navigation Company's cargo boats. When we left Montevideo we heard that France and Germany were at war, and that there was every possibility of Great Britain sending an ultimatum to Germany. We saw several steamers after leaving the port, but could get no information, as few of them were fitted with wireless and passed at some distance off. When about two hundred miles east of Rio, our wireless operator overheard some conversation between the German cruiser *Karlsruhe* and a German merchant ship at anchor in Rio. It was clearly evident that the German merchant ship had no special code, as the conversation was carried on in plain German language, and our operator, who, by the way, was master of several languages, was

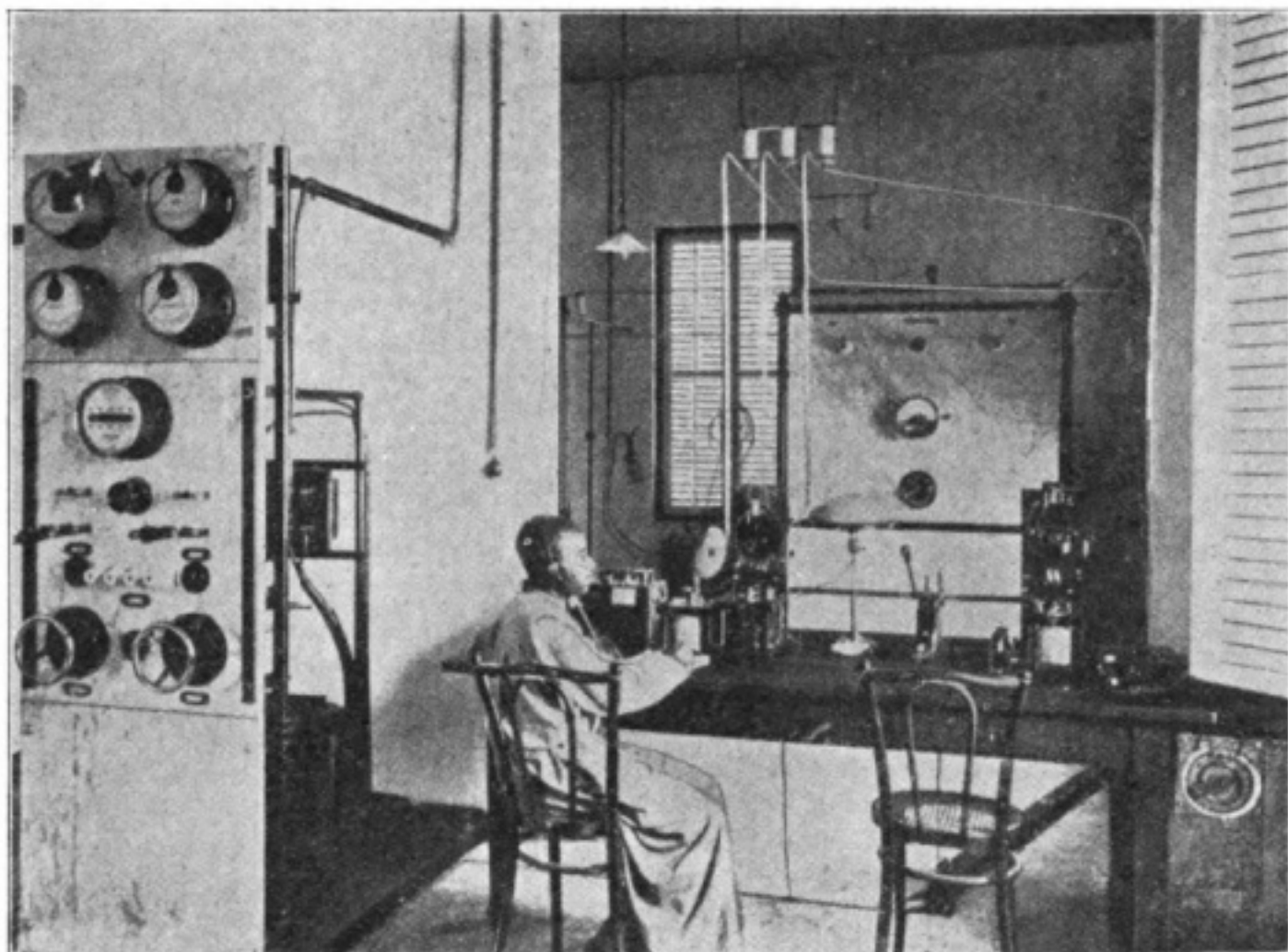

A native operator employed in the German station at Dar-es-Salaam, now destroyed by the British.



A French Portable Wireless Telegraph Station in service at the front.

able to interpret these messages without the slightest difficulty. It was then that we learned that Great Britain was at war. The German cruiser was inquiring from the German merchant ship what British vessels were leaving Rio, and asking for any information which might be of use. We also picked up some news of German victories in Belgium which were given out by the German merchant ship. It was clearly evident that the *Karlsruhe* had information about our ship, and expected us to be in the position she anticipated, for she sent out a signal to us in English, asking us for our latitude and longitude. This our operator, under the instructions of the captain, declined to give. The German operator evidently got furious, as he called us an English 'swinehound,' and said, 'This is a German warship, *Karlsruhe*; we will find you.' Undoubtedly he thought he was going to strike terror to our hearts, but he made a mistake.

"That night we steamed along without lights, and we knew from the sound of the wireless signals that were being flashed out from the German ship that we were getting nearer and nearer to her. Fortunately for us, about midnight a thick misty rain set in and we passed the German steamer, and so escaped. Our operator said that we could not have been more than eight or ten miles away when we passed abeam. Undoubtedly our wireless on this occasion saved us from the danger from which we escaped. This cruiser must have got notice of the whereabouts of several vessels, as we could gather from her signals that she was flashing out signals in all directions."

A Soldier's Story.

An interesting letter has been received from Mr. S. B. Balcombe, of Marconi's Wireless Telegraph Company (Traffic Department), from which we are able to make the following extracts—through the courtesy of the Marconi Company. Mr. Balcombe is serving with the Royal Engineers, and went abroad with the British Expeditionary Force. Writing under date of September 18th, he says:—

"The Wireless Section to which I am attached consists of a non-commissioned officer, a mechanic, two drivers, and four operators—eight in all. The first week abroad was fairly uneventful, except for the

novelty of our surroundings; but that soon wore off, and we settled down to business in grim earnest. We were longing to get into action, but, being attached to the headquarters staff, such an opportunity was denied us. We accompanied the British troops on their retirement into France, and, although the withdrawal was far from our liking, we were very cheerful, realising that the movement was expedient. But when the order came to advance a complete transformation passed over us, and our spirits rose fully one hundred per cent. On September 9th our section was ordered to join an army corps then in action, and we looked forward with glee to 'having a go' at the enemy. On the way to join our division we came across a German portable wireless station, which had evidently just been dismantled and was about to be taken away by the retiring Germans when a shell from one of our guns must have hit it 'fairly and squarely,' for there was a horrible mess when we arrived upon the scene. Three horses were buried beneath the shattered station, and close at hand lay the body of a dead German soldier—probably one of the wireless operators—a piece of shell embedded in his skull. It commenced to rain as soon as we set out on our march, and when, near midnight, we reached our destination there was a torrential downpour. At daybreak we were again on the move, and the following day were ordered to join a cavalry division. I came across Mr. Jezzard, one of the operators at the Marconi station at Clifden, hard at work operating a cable waggon, also a member of the Marconi House Staff, who is in the R.F.A., looking fit and well. It was a strange experience to meet on the same day and exchange hearty hand-shakes with two of one's colleagues in a foreign land. When we reached the cavalry division which we were ordered to join we encountered the heaviest fighting that had been experienced by our troops up to that time. In front of us were six howitzers, behind us were six more howitzers, and on our right were another six howitzers, and all of them within one hundred yards from where we were. What with the German guns and our own, the noise was simply terrible. The German guns could not find us, and, although the cannonade proceeded for hour

after hour, we came through untouched. It was my lot to witness a particularly distressing sight. One of our ambulance columns engaged in collecting the dead was noticed by Germans, who immediately opened fire on it, killing one sergeant and six privates, and also nine horses. This abuse of the Red Cross was fiercely resented by our fellows, who would have made it hot for the Germans had they been able to get at them."

Wireless and Neutrality.

The controversy between the Marconi Wireless Telegraph Company of America and the United States Government regarding the receipt of wireless messages at the

Orders of August 5th and September 5th last, authorising him to take such steps as he considered necessary to prevent the receipt for delivery, or the transmission of non-neutral messages, the Secretary Daniels announced the intention of the Navy Department to continue to retain censors at the American Marconi Company's stations, "in order to enforce the neutrality of the United States during the conflict in Europe."

On September 24th the Company filed in the United States District Court a bill for an injunction to restrain the Secretary of the Navy and four naval officers, on duty as censors at the Seagate station, from censoring the Company's messages, and possibly closing that station. Mr. Griggs informed

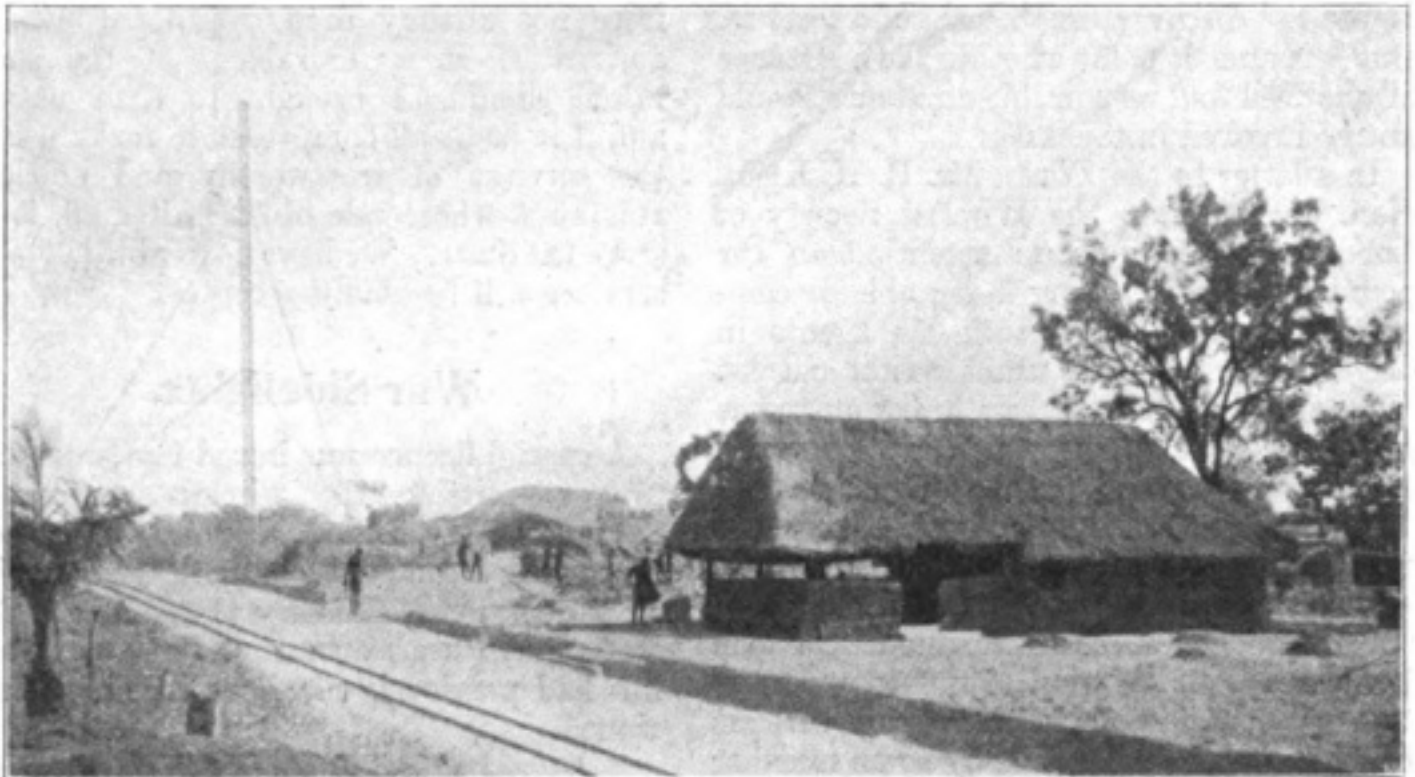

The German Station at Kamina (Togoland).

Siasconset station from the British cruiser *Suffolk* has resulted in the closing down of that station. The Secretary of the Navy, Mr. J. Daniels, in a letter to Mr. John W. Griggs, the President of the Marconi Wireless Telegraph Company of America, said that the President of the United States had been advised by his Attorney-General that he had full authority, in view of the extraordinary conditions existing, "to close down, or take charge of and operate, the plant of the American Marconi Company's station, should it be deemed necessary to secure obedience to his Proclamations of neutrality." In accordance with the Executive

the Secretary Daniels of the filing of this bill, and asked whether the Secretary would be willing to await the result of a judicial decision on the rights of the Government and of his Company. Notwithstanding this request, Secretary Daniels, at the direction of President Wilson, ordered that the Siasconset, Mass., station be closed at noon on September 25th, and the order was carried into effect.

Wireless Police.

It is clear that in the new strategical conditions the restriction of amateur wireless activity is necessary, and the manner in

which the authorities are searching out unauthorised stations is an assurance that the danger of communication with the enemy by means of wireless telegraphy is practically non-existent. The question arises, however, whether the most effective means for securing this end has been chosen by ordering the closing of all amateur stations up and down the country. As is well known, it is possible to receive wireless signals by means of indoor aerials, and it would be difficult for the authorities to detect instances where this means of reception is employed. It has been stated in a German technical publication that by means of indoor aerials transmission over a length of 150 miles has been achieved. No doubt the authorities have taken the necessary steps to discover such use of wireless. But it is a moot point whether the assistance of qualified and responsible amateurs should not be invoked in this task.

In a letter to the *Times*, Mr. R. H. Klein, Hon. Secretary to the Wireless Society of London, properly draws attention to the possibility of the enemy being able to communicate quite easily with his agents in England without the usual postal checks. He states that "Until war broke out some hundreds of licensed experimenters, fully known and trusted by the authorities, all British subjects, were at all times, day and night, keeping watch on all wireless messages, and formed a most effective supervision of transmitting stations in England. No one has been able to use wireless apparatus for the transmission of even a single message without being detected or checked by some member of the Wireless Society, and I attribute to this constant vigilance the very marked decrease in, if not complete disappearance of, persons using wireless stations without a proper licence." Mr. Klein suggests that the authorities should enrol a number of members of the Wireless Society to keep watch over the use of illicit wireless transmissions, and in this suggestion he is supported by Dr. Erskine-Murray, who adds that special licences should be granted to approved amateurs who, if thought advisable, might be sworn in as special constables, with instructions to keep day and night watch on all signals.

We have no doubt that the authorities have taken all steps which they consider necessary to watch over amateur wireless

operations throughout the country during the period of the war, and if they have not invited the co-operation of amateurs it must be assumed that they are quite satisfied as to the adequacy of their measures, to evade which no attempts have been made, so far as our knowledge goes. It will be remembered that, in a recent statement issued by the Home Secretary, Mr. McKenna announced that the Post Office had established a special system of wireless detection, by which any station actually used for the transmission of messages in this country could be detected, and it is unlikely that the method adopted is known to anyone beyond those actually responsible for carrying it out. At the same time, if the suggestions made by Mr. Klein and Dr. Erskine-Murray have not already been considered by the authorities, it is desirable that the point raised should be brought to their notice, and if it be at all competent to make use of the services of trustworthy and efficient amateurs, whose sole object, after all, is to serve the State. We have no doubt that such services will be gladly accepted.

War Sidelights.

A special licence was issued on September 27th permitting the wireless station at Sayville, Long Island, U.S.A., to operate for regular communication with Germany for a period until January 1st, 1915. The station has been operating for some time, but had previously not been officially sanctioned.

* * *

In the great courtyard of the Ecole Militaire, Paris, on September 26th, a French reservist named Gruault received the punishment of degradation for espionage. He had tried to sell to Germany a plan of the Eiffel Tower wireless station.

* * *

The newspapers reported on October 7th that G. D. Smith, an Englishman, wireless operator on the German freight steamer *Mazatlan*, rather than obey the command to communicate with the German cruiser *Leipzig*, for which the *Mazatlan* had a cargo of coal, he wrecked the wireless apparatus. The cruiser later found the steamer near Magdalena Bay and took on board coal and other supplies.

The Central News Kirkcaldy correspondent telegraphed on October 20th that unofficial information had been received, "from a reliable source," that a wireless apparatus had been erected at a house commanding an uninterrupted view of the Firth of Forth and situated a few miles from Kirkcaldy. It was stated that the military authorities stationed at Kinghorn were informed, and that as the result of a raid the apparatus for such a station was discovered.

At the headquarters of the West Riding Territorial Division at Doncaster a district court martial was held for the trial of William Sharpe, a civilian, of Thorne, who was charged with being in possession of wireless telegraphic apparatus and alternatively he was charged with harbouring a person (his son) who was in possession of a complete wireless installation. A postal official gave evidence that the wireless outfit for receiving messages was a toy set worth £4 10s., and was capable of receiving messages from a distance of 200 miles under fair conditions. The court, however, found the accused not guilty, and he was discharged.

The attention of all amateurs should be drawn to the case which was recently heard at the Old Bailey where a young man was sentenced for maintaining an unlicensed station. The defendant was Morgan Adolf Watsdorf, a clerk, of Shepherd's Bush, and he was indicted for establishing and working a wireless apparatus without the permission of the Postmaster-General. Defendant pleaded guilty on three counts relating to 1913 only.

For the prosecution it was stated that the Post Office effectually dismantled the apparatus on August 5th, the day after the declaration of war, and the prosecuting counsel accepted the plea relating to last year.

Addressing the prisoner, the Judge said: "If you had been convicted of maintaining a wireless station in time of war, hobby or no hobby, I would have given you the full sentence the law permits, because it is not a time to look at hobbies when you do things which are a danger to the State. But when you are only convicted of doing this thing in 1913, and there is nothing to show that you contemplated in the future being useful to the enemy, I am bound to say I feel a

little bit at a loss to know why this tribunal has been selected for this case. I do not think I can justly do more than send you to prison in the second division for a fortnight and order your apparatus to be forfeited."

This case should serve as a warning to other amateurs who in the past may have put up stations without troubling to take out a licence.

Statements appeared in the Sunday papers, on October 17th, of the alleged discovery of a wireless installation at the house of Professor Arthur Schuster, Yeldall, near Twyford. We are glad to be able to publish the following statement with regard to the matter made by Professor Schuster, who, it should be added, is secretary of the Royal Society:

"On June 18th of this year a licence to establish and work apparatus for wireless telegraphy was granted by the Postmaster-General to Professor Schuster, restricted to the use of the licensed apparatus for the purpose of receiving time signals. When the war broke out Professor Schuster and his family were on their way to the Crimea to observe the total solar eclipse, but they proceeded no further than Constantinople on account of the war. Yeldall was let furnished for ten weeks from July 14th to September 22nd. When war was declared, and during the absence of Professor Schuster and his family, officials from the Post Office called at the house and took down the whole installation and packed the same away into a box, which they nailed down and sealed. After this was done, and in consequence of rumours reaching the ears of Professor Schuster's son-in-law, Dr. Robert Hutton, of Sheffield, the latter gentleman wrote on or about August 21st to the Chief Constable of Berkshire informing him that the wireless installation had been taken down as above mentioned.

"Professor Schuster and his family arrived in England on September 12th, and went back to Yeldall on September 23rd. On Thursday, September 24th, or on the next day, an official from the Post Office called at Yeldall and saw Professor Schuster's wife and daughter. He inspected the box containing the wireless installation and declared himself satisfied. Nothing further transpired until Tuesday, October 13th, when Police-Inspector Goddard called with

a constable at Yeldall and inspected the said box. Professor Schuster saw him and told him that the installation was for receiving purposes only and could not be used for transmission, and that time signals had only been received from the Eiffel Tower, as the apparatus was not sufficiently sensitive to receive messages from the German station at Norddeich. The next morning the same constable called and took the box away. On Saturday, October 17th, Inspector Goddard and the same constable called

again and left a search warrant for the said wireless installation which they had already taken away on the previous Wednesday.

"It is clear that the statement in the Sunday papers that a wireless installation was 'discovered,' meaning, as it does, that it was used for traitorous purposes, is a gross and cruel libel; all the more cruel as Professor Schuster's only son is an officer in the Yeomanry, and expects to be sent to the front in a few weeks."

Wireless Weather Report.

A COMPARATIVE study of the annual reports issued during the past few years by the Meteorological Committee affords an interesting illustration of the ever-increasing service which wireless telegraphy had rendered to meteorology. During the year ended March 31st last 5,752 wireless reports were received at the office from Atlantic liners, this representing an increase of 350 reports as compared with the previous twelve months. It is gratifying to note that there has been some improvement in the rate of transmission of these reports. Whereas in 1912 only 272 out of 5,400 messages, or about 5 per cent. of the total, reached the office in time for inclusion in "to-day's" map, in the daily weather report during the year covered by the period reviewed in the annual report 394 messages, or 7 per cent. of the total, reached the office in time for inclusion. 3,268 messages, or 57 per cent. of the total, reached the office in time for inclusion in "yesterday's" maps in the daily report, as compared with 50 per cent. of the messages of the previous year. Thus, whereas during 1912 about 50 per cent. of the messages suffered so much delay in transmission as to be only useful from the point of view of the collection of material for study, the percentage was reduced to 43 in 1913. As the improvement has been most marked in

the later months, the hope is expressed in the report that the figures for next year will show a further advance. We have no doubt that this hope would have been realised but for the war, which will doubtless considerably disturb this useful service, and in all probability the showing for next year will be no criterion of the increasing advantage of wireless to meteorology. In the ordinary way the service is subject to certain conditions, which explain the small percentage of messages received in time for inclusion in "to-day's" maps, but the percentage is an increasing one, and in the course of time it should be possible to effect the necessary adjustment of conditions to bring about a much greater result. We note with satisfaction that, from time to time, messages reach the Meteorological Office within about an hour, or an hour and a half, of the time of observing, and when these messages have been received sufficiently early to be considered with the latest state of observations from land stations at the time of issue of the weather forecasts, they have been of great utility. One instance of this service may be cited. On March 19th effective storm warnings were issued to the south-western districts which were based entirely on reports received by wireless telegraphy.

Practical Hints for Amateurs.

An Experimental Wireless Station.

By S. W. PILLING.

SOME notes concerning my self-constructed transmitting and receiving apparatus may be of use to amateurs who seek to construct a station on simple and economic lines. I use my aerial both for transmitting and receiving: it consists of five 80 ft. lengths of 14's S.W.G. hard-drawn copper wire, suspended between two poles, each 30 ft. out of the ground. The wires are separated by bamboo spreaders; each wire is spaced 18 in. apart by ordinary porcelain drawer knobs, which I have found to be perfect insulators. The aerial is made to wind up from each end, so that any break in the wires can easily be mended. The lead-in is taken from each wire down to within one yard from my cabin. All the wires are soldered together with a piece of rubber-covered cable $\frac{1}{2}$ in. dia., which passes through a glass tube into the side of the cabin.

Of the two receiving jiggers in use one is stationary, and is made in accordance with the design given by Mr. J. Barton in THE

WIRELESS WORLD for December, 1913; the other is for a portable station which I am licensed to use within a radius of five miles from my residence. It is of the loose-coupled stud type.

The secondary, S, is wound with 3 oz. of 36 S.W.G. S.C.C. copper wire on a millboard tube, 5 in. dia. by $10\frac{1}{2}$ in. long, and tapped out to 13 studs. It is then given two coats of shellac, and a piece of insulating fibre is laid on tightly, and over this the primary, C, is wound. This consists of $\frac{3}{4}$ lb. of 28 S.W.G. S.C.C. copper wire, which is also well shellaced and tapped out to 36 studs. The whole is then fixed in a box, 11 in. by 7 in. by 7 in., with detectors, potentiometer, variable condenser, and switches mounted on top. The potentiometer, I, for this set was copied from a design which appeared in THE WIRELESS WORLD for June, 1913, with an additional switch for cutting the battery when not in use, to prevent its running down. R is an ordinary pocket lamp battery fixed inside the box underneath the coil. The block condenser,

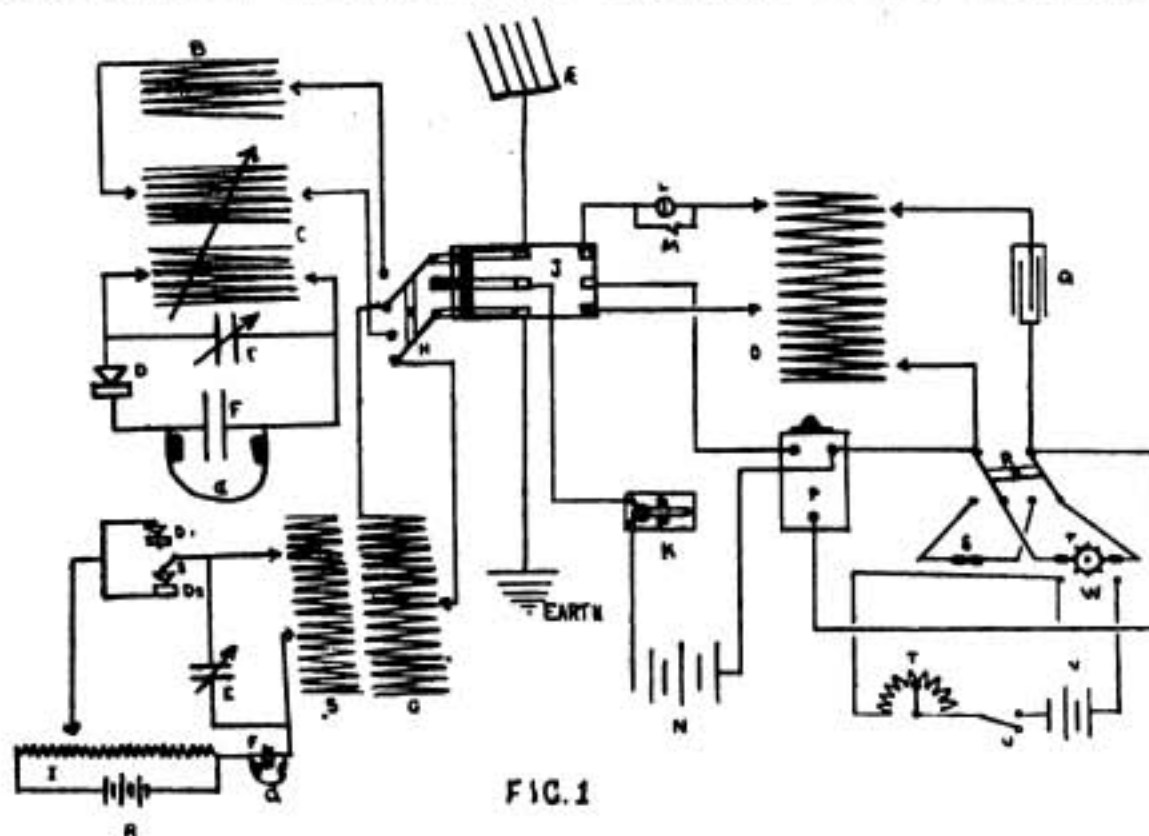

F, consists of 20 sheets of tinfoil, 2 in. by 1 in., interleaved with wax paper, also inside the box, and is shunted across the 'phones. The variable condenser, E, is of the sliding

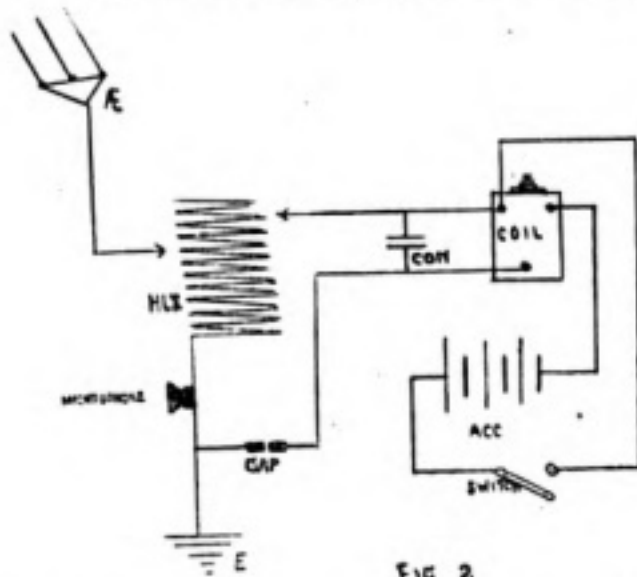

FIG. 2

type, 10 zinc plates interleaved with glass plates, 2½ in. by 3½ in.

The detector, D¹, is a zincite bornite combination; D² is carborundum. I have tried many crystals, but these two have proved to be the most sensitive and reliable. Bassano's detectors are used as described on page 583 of *THE WIRELESS WORLD*, December, 1913. These, I think, are better than soldered crystals in cups, as the heating of a crystal greatly reduces its sensitiveness. My 'phones, G, are each 2,000 ohms; these were purchased, but before that I used an ordinary telephone receiver wound to 2,000 ohms, with 3 drms. of 50's. S.C.C. copper wire, afterwards filling the inner casing with bees'-wax to the level of the pole pieces. By this means the signals were much sharper and clearer. With the set described I am able to hear the principal stations from 200 to 8,000 metres, also ships in the North and Irish Seas quite clearly.



The Author and his Wireless Set.

My transmitting set is quite a simple affair, as my licence only permits me to send to a station three miles distant. I use a motor ignition coil, P, which gives a good ½ in. spark, using 2 four-volt accumulators in series. I have two spark gaps, S being a fixed one, which gives a ruffle note. This is mounted on ebonite, with zinc electrodes. The rotary gap, T, thus gives a note similar to Nauen, and is made from a small model motor with the driving pulley taken off and replaced with one of ebonite, 2 in. dia., with a brass ring, into which are fixed 8 brass rivets, protruding ¼ in. from the disc. These form the electrodes, which revolve at 2,000 revolutions per minute—the maximum speed of the motor. The speed may be varied, however, by means of a small variable resistance, T, and a much lower note obtained. The main electrodes are mounted on ebonite similar to the fixed gap.

The high-tension condenser, Q, consists of 25 sheets of tinfoil, 4 in. by 3 in., interleaved with photographic plates, 5 in. by 4 in., wedged in a cigar box and filled with paraffin wax. The helix, O, is a spiral of 10's aluminium tubing, with wood rods, 10 in. by 1 in. dia., soaked in paraffin wax for supports. The glow lamp, L, is a four-volt Osram, connected in series with the aerial, with a switch, M, to cut it out when the aerial is tuned up for transmitting. The change-over switch, J, is so made that when I am receiving the current is cut off from the coil to avoid the danger of accidentally depressing the key and upsetting the crystals; this arrangement can be clearly understood on examining Fig. 1. The tapping key, K, is a Morse practice key with an ebonite knob. The accumulator, Y, runs the motor for the rotary gap, and the switch, U, cuts out the rotary when I am using the fixed gap.

Fig. 2 is a diagram of connections for experimenting in wireless telephony which has given satisfactory results. The microphone I use is a carbon granule telephone transmitter with an ebonite mouthpiece. It must be understood the high-tension condenser for this circuit has about twice as many plates as that used for telegraphy, and if any reader of *THE WIRELESS WORLD* requires further information regarding my station I shall be glad to supply it.

A Portable Set.

By "GIBSOR."

IN the set described here, the aerial is of the inverted L type, supported by three bamboo masts, about 28 feet high at each end.

These masts are lashed together by ropes and, when in position in the field, are stayed by four or more ropes. The positions for the stays are best found by trial. A good method is to have two long stays from the top of each mast and three or four from the first joint or lashing down. Better

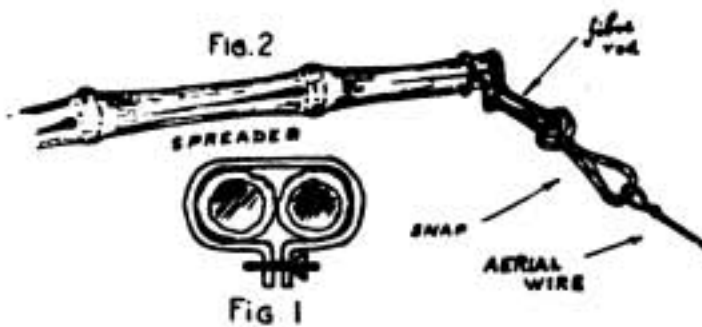

than rope lashings are iron rings or collars to clamp the masts—there being two at each joint. These must be carefully made to size and are illustrated in Fig. 1.

The spreaders are 3 feet 3 inches in length, and of bamboo, the insulation being effected by means of short lengths of fibre rod. As seen in Fig. 2, dog snaps are employed to facilitate fixing the aerial wire without having to twist it on each time.

The spreader at the lead-in end is fixed by rope to the top of the mast, while on the other end there is a pulley to allow the aerial to be drawn up or lowered. It will be found, when erecting, that some such arrangement is essential.

In practice it must be remembered that when up, the aerial acts as a stay to the mast in one direction. This is not so until the aerial is actually up, and provision, by means of a stay in the line of pull of the aerial, must be made for holding the masts up when no aerial is in position. This may seem obvious, but experience shows that it is very easily forgotten. The aerial is up, the masts seem well braced—then it becomes necessary to lower the aerial for some reason or other and the masts are suddenly noticed to be falling outwards.

With lashed masts, especially when expert lashing is not always available, the secret of success and of a workmanlike-looking

job is to get the poles lashed in line, one behind the other.

Reference to Fig. 3 will make this clear. It must also be seen that the direction of pull of the aerial is in line with the poles. The aerial is 60 ft. in length (2 wire) and is made of 18's gauge bare copper wire.

Loops are made at both ends to clip on to the snaps.

The lead-in is by a single insulated cable, 3/22's gauge, and is detachable by means of an ordinary connector.

The receiving net, switches and transmitting key are all contained in one box, size 24 in. by 9 in. by 8 in. deep.

The box has a sliding lid and one side opens outwards, forming a writing desk. It is thus easily supported on any kind of box available.

There are two D.P. change-over switches, one for receive or transmit positions and one for "stud bi" and "tune," and an earthing switch together with the transmitting key. The "stud bi" circuit consists of the jigger primary, which is wound on a cord tube 4.2 in. diameter with some 65 turns of 22 gauge enam. copper wire.

This is tapped off to the nine studs of a switch.

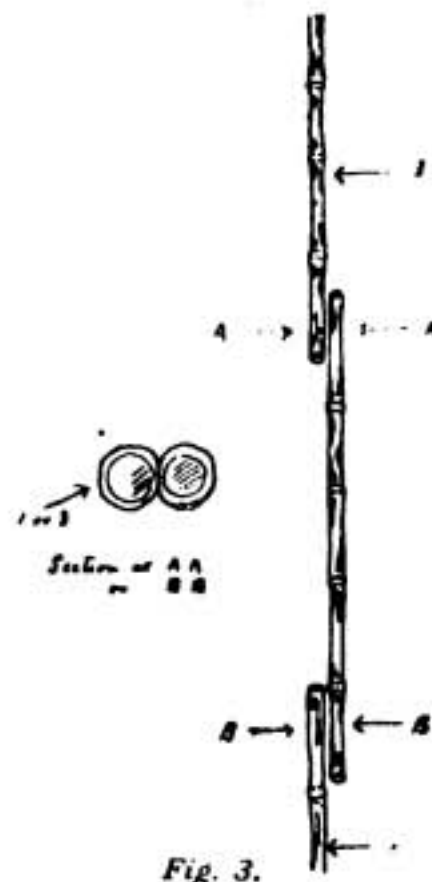

The loading coil is also wound with 22 gauge wire on a wooden roller 2½ in. diameter and 9 in. long.

The crystal detector, which is zincite and chalcopyrites, is in series with the phones and these two are across all the inductance from aerial to earth when the switch is in the "stud bi" position.

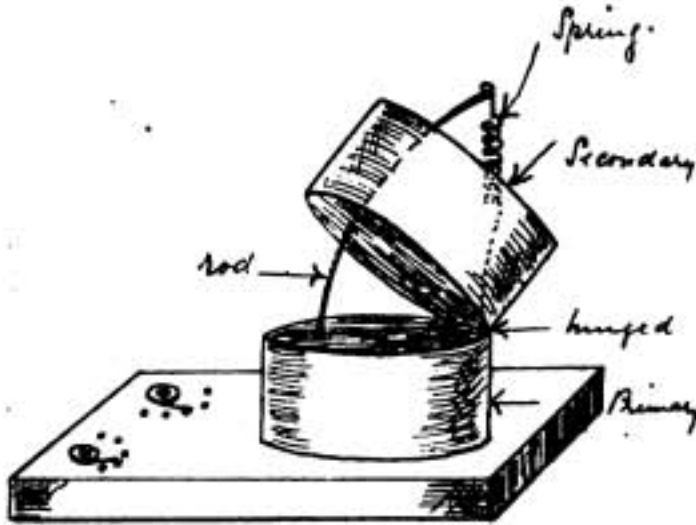

Fig. 4.

In the tune position the jigger secondary is brought into play.

This consists of a 4.2 in. diameter tube wound with 28 gauge D.C.C. wire and tapped off to six studs of a switch.

The number of turns between the studs is as follows:—15—15—31—34—35—27, or about 160 turns in all.

Variation of coupling is effected by securing the primary on to a base board—which also carries the two stud switches—and hinging the secondary on top of the primary.

The secondary is held in any position by means of a piece of $\frac{1}{2}$ in. diameter screwed brass rod, bent into the arc of a circle, whose centre is the hinge.

This piece of rod is fixed into the wooden top of the primary coil and passes through a piece of wood glued into the bottom of the secondary coil.

A wire spring, one end of which hooks on to the rod holding it down, the other being soldered on to one of the hinge screws, causes the rod to bear against the wood in the bottom of the secondary, and so maintain it in any desired position.

To relieve the pressure on the wood, when it is required to alter the position of the secondary, the rod must be slightly pushed to the right. As seen in Fig. 4, there is a second loading coil in all respects similar to the first. This may be used to augment either the secondary or the primary inductance.

In the "stand bi" position, with a 60 ft. aerial, it is easy to get up to 2,500 metres, and with the judicious use of small condensers (say two sheets of tinfoil $2\frac{1}{2}$ in. by $1\frac{1}{2}$ in. and waxed paper) it is possible to "tune" such a wave-length.

The secondary variable condenser consists of $4\frac{1}{2}$ in. of $1\frac{1}{2}$ in. diameter brass tube, with an insulated portion of the same length but smaller diameter sliding within the former. This, though apparently small, is found to be most effective in tuning.

The buzzer, worked by a 4-volt flash lamp battery, is included in this box, the push switch being seen on the left side in Fig. 4. Low down on the left is a key which is kept pressed while sending is in progress. Its action is to "dis" the detector and also to short it with a small capacity. This is found to be a very effective protective device for this type of crystal, at any rate.

The telephones are 3,000 ohm double headpiece shunted with a blocking condenser. The D.C. fuse is also contained in this box.

The transmitting gear is contained in a box of the same size, there being room also for spare wire and tools.

The coil is a small motor-car coil taking about two amps.

The spark gap is direct in the aerial and there is a little tuning inductance for use if necessary.

In the earth side there is a small battery of condensers of considerable capacity to keep the wave-length down.

Everyone is up in arms against plain aerial transmission, but for a field set,

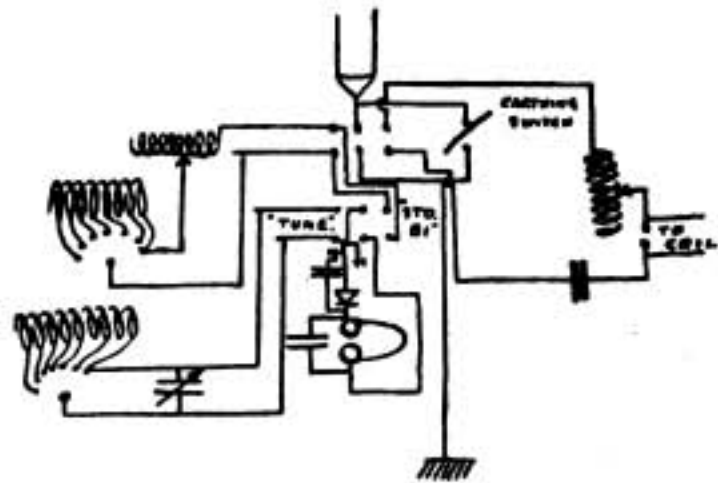

Fig. 5.

where a large distance is desired to be covered, and power is heavy to carry round, I think it may be excused. Some of these

small coils will easily work on 12 volts and give a remarkably fine note when adjusted carefully. The normal voltage for such a coil as the one mentioned above would be 4 to 8 volts.

In connecting up the transmitting side it is advisable to connect the high tension terminal—or one which usually goes to the spark plug on the car—to the aerial.

The test for this is that a vacuum tube glows on the aerial but not on the earth wire.

The spark gap consists of two pieces of $\frac{3}{8}$ in. diameter aluminium rod—one fixed and the other capable of being advanced by having a thread screwed on it. The earth is made by three lengths of galvanised iron wire netting each 1 ft. 6 in. by 6 ft., and 2 in. mesh. A copper lead is soldered to one end of each length.

The netting is held down to the ground by galvanised wire hooked round skewers.

Apart from their portability and ease of laying, these earths give splendid results.

A set such as described has just come through a week's wind and rain without a hitch, in spite of the fact that the lashings were not very well made.

Owing to lack of time and opportunity, the transmitting side was never tested as thoroughly as could have been desired, though signals were received a mile away.

The probable range on eight volts is five miles; this is judged from results with the same stuff on a slightly larger aerial.

The Delaware, Lackawanna and Western Railroad Company have completed a steel tower 402 feet high on the water front at Hoboken, N.J., for wireless service, and have installed a five-kilowatt, high-frequency Marconi set at that point. On September 19th wireless messages were received direct from Hoboken at the Lackawanna wireless station, Buffalo, a distance of 410 miles, on a wave-length of 2,250 metres. These messages were copied at intermediate wireless stations located at Scranton and Binghamton and at Binghamton the dots and dashes were heard in all parts of the wireless room. The test having proved highly successful, a regular wireless service will shortly be inaugurated.

* * *

Mr. A. A. Isbell, superintendent of construction, proceeded to Ketchikan the

A "Wireless" Parson.

St. Luke's Church, Bath, is notable for its "wireless" installation between the tower of the church and the adjacent vicarage. Is this the first church to be so equipped? The vicar, the Rev. C. E.



St. Luke's Church, Bath, fitted with Wireless Installation.

Doudney, is deeply interested in science and mechanics. He taught himself the whole wireless telegraphy, put up his own installation, and bears the reputation of being one of the most expert amateurs in England. It is said that he is able to communicate with homecoming missionaries while they are still in the Bay.

latter part of May and has been actively engaged in clearing land, erecting the operating building, living quarters for the staff, and preparing the mast foundations since that time. Mr. O. B. Moorhead, of the San Francisco construction staff, left for Ketchikan on July 25th to assist in the work. Mr. D. J. Moir, of the Seattle construction staff, has been instructed to proceed immediately to Astoria to commence the erection of the station at that point.

* * *

The work of erecting two wireless stations, one at Posadas and the other at Puerto Aguirra in the Argentine province of Misiones is being actively carried out by Commander Pedro L. Padilla on behalf of the Argentine Government. He is assisted by Mr. Jeronimo Reynaud, who is acting on behalf of the Administration of Posts and Telegraphs.

The Amateur Handyman

A Morse Practice Set.

BY CYRIL C. BARNARD.

AS amateurs are, for the time being, forbidden to make use of their stations, and are, therefore, no longer able to listen to "real" signals, it would be worth their while to devote attention to the devising of means for keeping up their Morse practice. I have been engaged on the problem of constructing a buzzer set to enable me to keep in practice, and have devised a circuit which gives excellent results for two operators intercommunicating in the same house but in separate rooms, thus giving the impression of distance and isolation experienced in actual practice. As this may be of some interest to readers of *THE WIRELESS WORLD*, I give a brief description of it below.

The materials required are: (1) sufficient bell wire to connect up two rooms, (2) a buzzer, such as is commonly used for testing crystal detectors, (3) two telephone receivers, (4) two tapping keys, (5) two dry cells, or other suitable source of current, and (6) two miniature "jiggers," which can easily be constructed in a few minutes, as they need not be variable.

To take the last named first, the dimensions of the coils and gauge of the wire are practically immaterial. My jiggers are

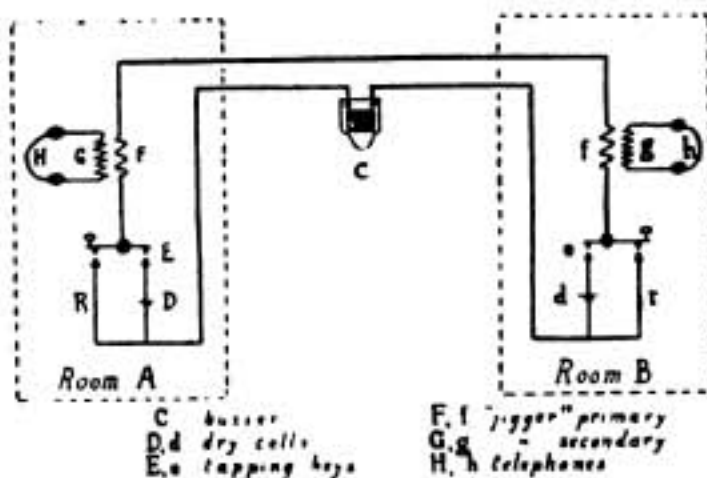

constructed as follows: The primary winding consists of a single layer of 20 S.W.G. double cotton covered wire on a bobbin $1\frac{1}{2}$ in. long and $\frac{1}{2}$ in. in diameter. This is

merely covered with a layer of paper and on it is wound a layer of 34 S.W.G. single silk covered wire, thus constituting the secondary winding of the jigger. It is convenient, but not necessary, to mount the whole on a small base and fit terminals for primary and secondary connections. The type of telephone is also to a large extent unimportant, but the most convenient form to use is the ordinary wireless telephone receiver with headband, either single or double. The resistance makes little difference; I use 4,000 ohms double headgear. The other materials and instruments need no description, and the accompanying diagram of connections is self-explanatory.

It is best to place the buzzer, C, outside both the rooms and to muffle it so that neither operator can hear it directly, but only in the 'phones. The chief features of the circuit are, first, that each operator hears in his 'phones not only what the other but also what he himself transmits, thus rendering it easier to transmit and to determine the character of one's sending; and, secondly, that the signals heard with such a set are scarcely to be distinguished from those heard in wireless telegraphy. Each operator can vary the note if he desires to by inserting a variable resistance at R and r. I have found that the ordinary inductance coil of my wireless receiving set serves the purpose of a variable resistance quite well, but a more compact type would, of course, be more convenient.

If only one pair of 'phones is available, the jigger, GF, can be removed and the buzzer, C, inserted in its place. The operator at A will now work by the sound of the buzzer itself and can dispense with 'phones, conditions at B remaining the same as before. Should one desire practice in reading faint signals, the coupling of the "jiggers" may be made variable; the strength of the signals can then be reduced or increased at will. It saves a great deal of trouble and confusion with connections if the set for each room is mounted on a board with the connections permanently made.

An Efficient Detector.

BY W. A. BRADY.

THIS detector is made from the following material: A piece of hardwood, size 3 in. by 4 in. by $\frac{3}{4}$ in.; a bolt about $2\frac{1}{2}$ in. long, and nut; 2 pieces of springy sheet brass, one $2\frac{3}{4}$ in. by $\frac{1}{2}$ in., the other $1\frac{3}{4}$ in. by $\frac{1}{2}$ in.; 1 piece of thicker sheet brass, 2 in. by $\frac{1}{2}$ in.; 2 old ceiling roses or fuses, one with flat brass plates and screws, the other with brass plates containing wire holders and all screws; an old lamp holder; piece of $\frac{3}{8}$ in. brass-cased tube 2 in. long, cut into three portions—viz.: 1 in., $\frac{5}{8}$ in., and $\frac{3}{8}$ in. long; one ordinary beer bottle stopper (with flat top preferred); and a finely threaded brass screw, 1 in. long at least, and nut.

Drill hole in one end of each piece of springy brass to take small cheese-headed screw and a larger hole in the other end of a longer piece to take a bolt, and bend the smaller piece as illustrated.

A brass plate containing wire holder is used for upper mineral holder and is secured by cheese-headed screw to under side of the two pieces of springy brass.

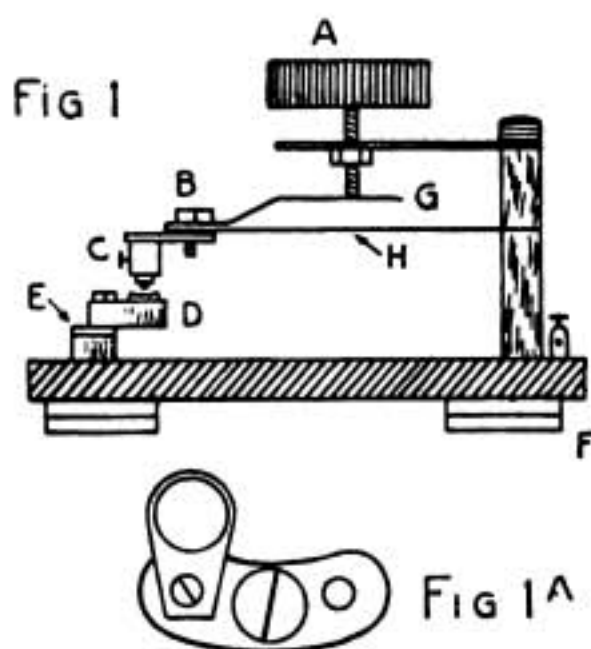

The thicker piece of sheet brass has a hole drilled in one end to allow the fine-thread screw to pass through, the nut from the screw being soldered to the under side of the brass, which also has a hole drilled in other end to take the bolt. Remove the spring fittings from the lamp holder, leaving two cups; these will screw on one of the

flat brass plates from the fuse, the plate being secured to the base by an ordinary brass screw through a piece of brass-cased tubing, $\frac{3}{8}$ in. long. These form the lower mineral holders; the small holes in the fittings will need enlarging a trifle to take screws.

Saw off screw part of stopper and fix fine-thread screw into head of stopper, giving same several coats of cycle black enamel to thoroughly insulate it. By fitting these together it is possible to make suitable connections under the base to two terminals. If preferred, 8 vulcanite washers can be screwed under the base, 2 to each corner. A coating or two of shellac varnish will add to the appearance of the base, if this cannot be polished.

A coat of lacquer will keep all brass bright, and it should be applied in a warm temperature.

The mineral holders can be moved either way, thus allowing a selection of mineral surface, and screws from fittings can be utilised.

A steel, gold point or light copper wire spring can be soldered on to one end of a spare brass plate from fuse or rose, enabling a variety of detectors to be tried for sensitiveness. I have tried gold point and silicon, but found silicon only sensitive in places; zincite and copper pyrites being very good, and zincite and boronite a trifle better (no battery being used).

A Wave Meter.

By EX-OPERATOR.

THE following is the description of a simple wave-meter I have constructed which does not contain any variable disc condenser—a piece of troublesome mechanism for the amateur to make. Although this eliminates the great range of wave-lengths obtained with a circuit using that instrument, it gives quite a sufficient number for the ordinary experimenter, there being 35 in all giving a range between 100 to 1,200 metres.

The inductance consists of 20 turns of No. 20 S.W.G. d.c.c. (shellac varnished) wire

E

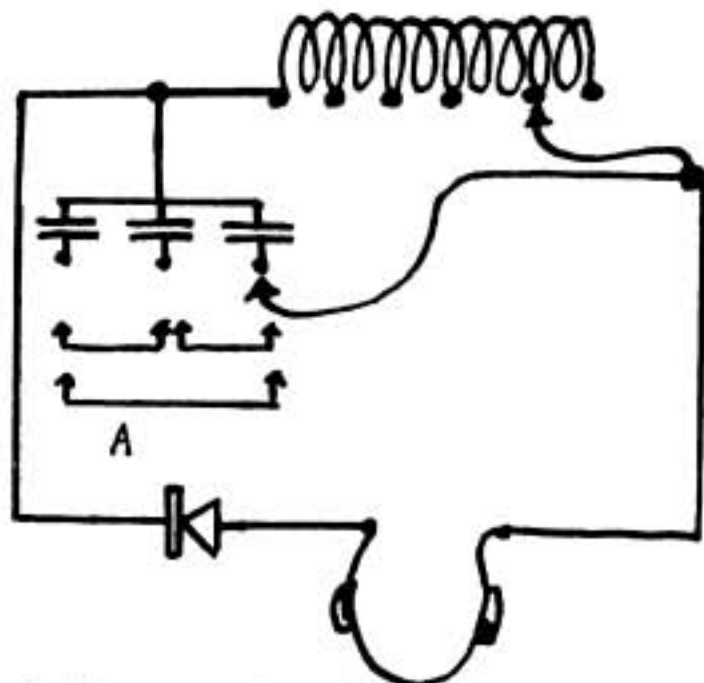

A. Plug connections for putting condensers in parallel.

wound on a cardboard tube 4 inches in diameter. This is tapped off in five different points to a five-way switch. The free end of the wire is connected to a piece of strip brass to which the one end of three condensers of capacities .01, .0008, .0008 mfd. is attached.

The other ends of these are connected to the lever of the switch by means of a plug. These three condensers can be used either separately or two or three in parallel, these further connections being made also with suitable plugs. The detector or "buzzing" circuit is connected in the usual way as shown in the diagram. The meter was calibrated against a standard wave-meter by buzzing the various circuits and reading the wave-length given by the standard meter.

Among the Wireless Societies

Barnsley.—Mr. G. W. Wigglesworth read a paper entitled "Various Combinations of Crystals" at the October meeting of the Barnsley Amateur Wireless Association. In order to retain the members' interest, this association has agreed upon a definite programme during the winter months. Meetings will be held (at Shaw Lane Cricket Ground) each Wednesday evening. The first half-hour will be devoted to buzzer practice, to be followed by half an hour's lamp signalling. The remainder of the evening will be occupied by the systematic study of all the instructional articles which have appeared in *THE WIRELESS WORLD*. Members will take it in turns to conduct the study of these articles. The members of the Barnsley Association are to be congratulated upon the excellent use they propose to make of the period of enforced temporary dismantling of amateur stations. We shall follow their work of the coming session with particular interest, and will be pleased to answer any questions or elucidate any points that may arise in the course of their study of *THE WIRELESS WORLD* articles.

Birmingham.—In his presidential address to the members of the Birmingham Scientific Society at the Midland Institute on October

7th, Mr. H. W. H. Darlaston announced that the Birmingham Wireless Association was now associated with the Society and shared their headquarters. Owing to the circumstances of the moment, their activities were somewhat circumscribed, and he supposed it was possible there would be more restrictions on the performance of experiments and the despatch and receipt of wireless messages from the present crisis; but there were amazing possibilities before the science. How it had grown during the past eighteen years, and almost entirely owing to the energies of Marconi! It was greatly to the credit of this country that so many of these highly important inventions had their first encouragement and application here.

Liverpool.—The course of study for members of the Liverpool Wireless Association outlined in the October number of *THE WIRELESS WORLD* is continuing merrily. At a recent meeting there was a practical demonstration of "Wiring for Ordinary Land Line Telegraph Instruments," and a suggestion made that during the period of prohibition of amateur wireless working the members should study ordinary telegraphy, using the Morse sounder, or buzzer. It was proposed that each member should provide himself with a portable outfit, consisting of

sounder (or buzzer), three terminal Morse key, dry cells, and a reel of about 110 yards twin cable. To secure uniformity a specification showing the requisite material, and the design of the case, will be prepared and submitted as a standard.

London.—Prof. J. A. Fleming, F.R.S., will deliver an address before the Wireless Society in London on "The Function of the Earth in Radiotelegraphy," on Friday, November 13th, at the Institution of Electrical Engineers, Victoria Embankment, W.C.

Newcastle-on-Tyne.—A meeting of the Newcastle Wireless Association was held on October 1st, when Mr. Norman Hall, of the North-Eastern Schools of Wireless Telegraphy, lectured on the "Telefunken System." It should be pointed out that meetings of this association will be held on the first Thursday in each month.

AMATEURS IN THE ANTIPODES.

THE last Australasian mail has brought us a letter from a "New Zealander" in Wellington which modestly forbids us to publish in full. He claims (and he is not without authority to speak on the point) that THE WIRELESS WORLD "is the finest publication of its class in the world," and if his gratitude for the assistance he has received from its columns has led our correspondent to speak of the magazine in too eulogistic terms, we must, nevertheless, admit that what he marks as an achievement has ever been the ideal aimed at by those responsible for its conduct. Wireless experimenters will be pleased to know that the section of the magazine in which amateur practice is reported is read with considerable interest in the Antipodes. It would be useful if, in return, Colonial readers would record their own experiences, for which purpose our columns are open to them. To judge from "New Zealander's" letter, the amateur in that country has not a very enviable time at the hands of the authorities, who have "forbidden the use of any wireless apparatus whatsoever." This prohibition, however, does not seem to have daunted the amateur, for there is in New Zealand a very flourishing Amateur Wireless Association, which has taken up an attitude in the present crisis

that should in time gain for its members a larger measure of freedom to carry on experiments in wireless than they have hitherto enjoyed.

* * *

The Association held a meeting at Victoria College, Wellington, on August 11th, with Professor T. H. Laby (Vice-President) in the chair. At that gathering Mr. C. P. Eden moved, on behalf of the President, the following resolution, which was unanimously adopted:—

That this meeting of the central executive of the New Zealand Amateur Wireless Association deeply regrets that a state of war has been forced upon the Empire, and hereby instructs the secretary to notify all local branches that all members are expected to strictly adhere to the Government instructions to dismantle all wireless apparatus owned by them, and that any person found to be disregarding these regulations will be reported to the central executive by whom the offences will be reported to the Post and Telegraph Department and the Defence Department.

This public-spirited attitude deserves every commendation, and it furnishes further proof that, with suitable encouragement, a well-conducted wireless society may be of inestimable service to the State. The members of the New Zealand Association have also had under consideration the question of providing a wireless set for the use of the expeditionary force sent to Europe.

Diary of Meetings.

MONDAY, NOVEMBER 2ND.

North Middlesex Wireless Club.—Shaftesbury Hall, Bowes Park, London, N.

WEDNESDAY, NOVEMBER 4TH.

Barnsley Amateur Wireless Association.—Meeting, Shaw Lane Cricket Ground.

THURSDAY, NOVEMBER 5TH.

Newcastle-on-Tyne Wireless Association.—N. M. Drysdale on "Wireless Telephony" at 29, Ridley Place.

FRIDAY, NOVEMBER 13TH.

Wireless Society of London.—Prof. J. A. Fleming, F.R.S., on "The Function of the Earth in Radiotelegraphy," at the Institution of Electrical Engineers, Victoria Embankment, 8 p.m.

The Wireless Direction Finder in Peace and War

ANY device that facilitates navigation and enhances the safety of "those who go down to the sea in ships" is naturally of great importance, hence the keen interest manifested in the practical and successful application of the wireless direction finder (Marconi-Bellini-Tosi System) during the few months prior to the outbreak of the present hostilities.

The toll of the sea is subject to no moratorium, and, despite the progress of invention, it will never be entirely required. Nevertheless, many ships have come to disaster of a nature which, by the aid of the wireless direction finder, could now be avoided, and several instances of such are fresh in the memory.

Every known and practised method of fixing the position of a ship at sea suffers from certain disabilities and inherent imperfections. The sun and stars may be obscured for days, during which the sextant is useless, the patent log leaves the calculation of drift very much to judgment, the lead is of use only in soundings, and the magnetic compass indicates only the course. Moreover, the compass may mislead through abnormal variation. For instance, near the entrance to Lough Larne on the north-east coast of Ireland "abnormal magnetic variation amounting to as much as $\pm 4\frac{1}{2}^\circ$ from the normal has been found to exist."* Notwithstanding these disabilities and imperfections the sextant, the log, the lead, and the magnetic compass are complementary and supplementary to each other, and each makes its indispensable contribution to the safe navigation of the ship. The function of the wireless direction finder is to supplant neither of them. It fills a hiatus which exists in spite of them, and acts as a check on them all.

The story of the sea contains more than one instance of a ship proceeding to the assistance of another in distress, which, on

account of fog, it has located only with difficulty and after the loss of valuable time. By the aid of the wireless direction finder on either the assisting ship or the ship in distress, the course of the former could have been directed straight to the latter merely by noting the direction indicated by its wireless signals.

The wireless direction finder enables a ship to detect the direction of an ordinary wireless telegraph station (on board ship or on land) at distances of from about five to 250 miles and more, depending on the power of the station and other conditions similar to those which govern the range of ordinary wireless communication. It therefore follows that all the deductions, such as distance, speed, and course, that may be made from the angles obtained by optical means, may be made from those obtained by the use of this apparatus.

The fact that the apparatus indicates the direction, but not the sense (that is to say, it does not differentiate between 20° off the starboard bow and 20° off the port quarter) is almost negligible, because a second reading after proceeding a little on a known course, an inquiry addressed to the sending station in case it is on a ship, or, in the case of a shore sending station, the observer's judgment, would dispel the ambiguity.

In fog the approach of a wirelessly fitted ship on a course which would result in a collision could be detected and a disaster obviated.

As a means of enabling ships to make narrow passages, such as the Straits of Belle Isle in Newfoundland and the Straits of Gibraltar, the apparatus is invaluable, given a wireless station at or near the entrance to the Straits; also it is useful in the same degree in rounding headlands on which wireless stations may be established.

So much for the applications of this invention in time of peace. In war it is destined to be of equally important service. The oceans are wide, but fugitive enemy

* See "Notice to Mariners" No. 1164 of 1914.

ships must at times make use of their wireless in order to communicate with their colliers or each other, and then their location could be detected by a ship within range equipped with the wireless direction finder. It is probably true that on battleships the turret-mounted guns of 50 calibres or so might, according to their laying, exercise a varying influence on the readings, but this could be overcome by fitting the apparatus on ships of other types, such as armoured cruisers.

It is conceivable that an enemy ship might pose as a land station, and, to serve its end, send false instructions to a merchantman; but if the latter were fitted with the wireless direction finder the plot could be detected and the enemy ship out-manceuvred.

Again this invention provides a splendid means of combating that formidable peril, the wireless spy, whose transmitting stations, be they hidden in forests, on the face of cliffs or on board ships in dock, may be located and hunted down either by direction finders set up in motor-cars or in fixed stations designed to scour definite areas. When the man disguises a wireless aerial may assume are borne in mind, it is apparent that the eye cannot be depended upon to locate the wireless spy even when his existence is known.

We are fighting an enemy who has mobilised all his scientific and engineering resources, therefore it behoves us to take advantage of every scientific development which may speed our conquest over him.

The opening meeting of the session of the Institution of Electrical Engineers was held on Thursday, October 29th, when the President, Sir John Snell, delivered his inaugural address. At this meeting a marble bust of Michael Faraday was presented to the Institution by Mr. Llewellyn Preece, on behalf of the family of the late Sir William Preece, K.C.B., F.R.S., Past President.

The Marconi Wireless Telegraph Co. of America announce the removal of their Northern District General Offices and Seattle Wireless Station to 2105-9 L.C., Smith Building, Seattle.

ADMINISTRATIVE NOTES

THE Siamese Radio-Telegraph Law issued in April last gives the Government the exclusive right to establish and work wireless telegraph and wireless telephone stations on Siamese soil and on board ships permanently anchored in Siamese territorial waters, and the privilege is reserved to the Department of Posts and Telegraphs in the Ministry of Communications.

Siam.

Wireless telegraph stations or field apparatus may be established and worked independently by the Army and Navy, but they are subject to such conditions as the Minister of War or Marine may sanction from time to time. Such stations may be opened to public correspondence, but only under special arrangement with the Department of Posts and Telegraphs. Installations on board merchant ships under the Siamese flag are only permitted when a licence has been granted by the Minister of Communications, and they must comply with the provisions of the International Radiotelegraph Convention, 1912. The Minister is further empowered to make such conditions as he may at any time deem desirable. Anyone who works, establishes or works apparatus contrary to the provisions of the Act is liable on conviction to imprisonment not exceeding six months, or a fine not exceeding five hundred ticals, or both, as well as the forfeiture of the apparatus. It is a penal offence to injure or in any way damage wireless apparatus or prevent the transmission and delivery of wireless telegrams.

There will be two stations in Siam, one at Bangkok and the other at Senggora, having a normal range of 1,000 kilometres and working on wave-lengths between 250 and 3,000 metres. Both stations are intended for Government Service.

* * *

THE Customs authorities of the Union of South Africa have recently given a decision to the effect that "wireless telegraphy apparatus" is to be classified under No. 114B of the Tariff, the general duty being at the rate of 3 per cent. *ad valorem*, and the whole of this being returnable in the case of British manufactures.

South Africa.

Wireless in Panama

A description of the Wireless Stations erected to control the great Canal Zone.

THAT part of Panama which is called the "Canal zone" is a strip of land ten miles wide by 49 miles long. Through the middle of it, with five miles on either side, runs the Canal itself.

America has sent her engineers and provided the money for the opening up of this great waterway between the Atlantic and Pacific coasts. She is therefore entitled to be proud of her enterprise and to colonise the Canal zone with her own people. The two great towns on the banks of the Canal which are given over to Americans are Cristobal and Panama. Here the American official makes himself as comfortable as circumstances permit within his residence, which, from a distance, looks not unlike a gigantic meat safe.

The whole of the Panama zone is under State and military control for obvious reasons. The Canal is of immense importance both strategically and commercially to the United States. It will afford harbourage for her largest battleships, and therefore must be under efficient control if it is not to be a source of danger to the nation which has produced it. For this reason it has been fortified, and further facilities of control are afforded by an elaborate wireless system. The principal station in the zone is situated just outside Colon, and works under the supervision of the United States Navy. The structures will comprise a power house operating house, and staff quarters. There will be four aerials of 1,512, 1,000, 600 and 300 metres. The normal wave-length for merchant ship business is 600 metres; between government ships, 1,000 metres, and between government shore stations 1,512 metres.

Two new skeleton towers, 600 ft. apart, each 300 ft. high, are in process of erection. They will rest on three bases 60 feet apart, forming a triangle, and set in cement. The intention is to use this station solely for

ship commercial work and certain classes of government business. A constant watch is, of course, maintained by the operating force.

The range of the large set will be 500 miles in the daytime and 1,000 to 1,800 miles at night. Under favourable conditions the station will work direct with Washington, D.C., and at all times with Key West and points within that radius. The site of the station is about one-quarter of a mile outside of the city limits of Colon, and faces about north. It is opposite the eastern breakwater at the entrance to the harbour. The site includes many bearing cocoanut trees, many of which will be cut down to facilitate the handling of the large antenna. This station will take care of the wireless service on the Atlantic side.

The machinery in the power house includes one 25-kw. set, 2 5-kw. sets and 2 2-kw. sets. Power is supplied by the Canal zone hydro-electric plant at Gatun, which also supplies the Balboa station on the Pacific side. In case of emergency the steam plants at Gatun and Balboa can be brought into use.

But as we progress eastward through the Canal we reach Gatun, a station, a dark town planted on the grass, whose chief feature is an enormous cyclopien wall which rises in three immense steps for nearly half a mile. This giant staircase is encumbered with machinery and crowned by a complicated network of steel. It forms the edge of the Gatun locks and the machinery is part of the emergency gates which, should the other barricades fail, would fall into position and effectively bar the onrush of water from the upper canal. The locks are the elevators for the ships. By them the biggest battleships can be raised to a height of nearly 80 ft. and brought down to the level of the sea. For the bed of the Canal lies some 85 ft. higher than the two

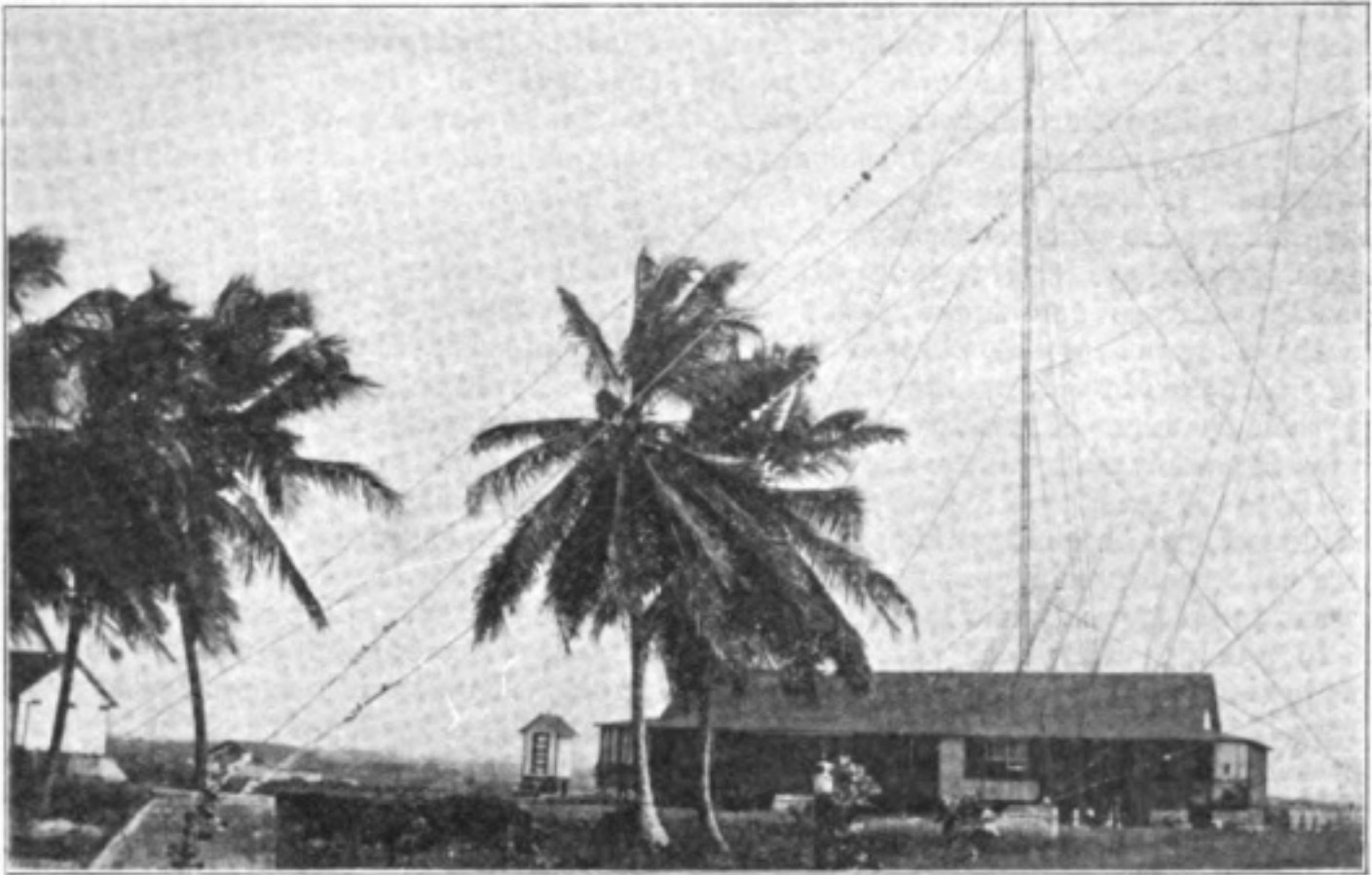

COLON WIRELESS STATION.

One of the chief stations erected for control of the Panama Zone.

oceans, and it is, in fact, a water-bridge thrown across the land. Each of the locks raises or lowers the vessel 20 ft. But magnificent as this work is, it does not appeal to the eye of the traveller with such arresting force as the Culebra Cut. After passing Gatun the Canal finds its way into the bed of the Chagres River until Gamboa is reached, where the Culebra Cut commences. For nine miles it cuts its way into the red earth, and the strange colouring of the precipitous cliffs thrown up on either side creates the impression of a wound not yet healed. On either hand are swamps and marshes or forests, so silent that one feels that nothing can have stirred in them for a thousand thousand years. That is the outward impression; but as the history of its making comes back to the mind the whole significance of the Culebra Cut takes another aspect. It is the work of Titans, and it has been accomplished in the face of untold difficulties. As fast as scientific man banked and terraced the sides, so did the mutinous earth slide back to its former place, and the work had to be done over again. Nine miles is the length of the Cut, and in this short distance twenty-one such

slides occurred, or, as an American author aptly remarked, "The American went on patiently terracing and cutting off the heads of the adjacent hills, and the adjacent hills went on pushing and kicking the dirt back into the hole like so many naughty boys."

The vision changes when one reaches the Pedro Miguel and Miraflores Locks. Here the view opens out, the Canal assumes a more imposing aspect, and plays the part of the great water highway between the two greatest oceans of the world. Water has covered some valleys and earth others. Everything has been turned upside down. In the Bay of Balboa the ocean now comes to where was once a famous hill. But Balboa has other interests besides constructional ones, for here is another of the Panama wireless stations. Its purpose is not so strategical as the one at Colon, and consequently it is not of such high power. It has been erected with a view to relieving the pressure of work at Colon, which will necessarily be felt as the wireless traffic increases, as it is sure to increase. Balboa Station will therefore deal principally with the vessels passing through the Canal.

At last we come to Ancon and Panama. Ancon is to Panama what Cristobal is to Colon, but it is a larger town. It is, in fact, the capital of the Canal's zone. Panama City is the most interesting of all the Panama townships. It teems with life, and, moreover, it has some signs of the older order of things. There are, for instance, its old Spanish churches and squares, and there are the dungeons of the Chiriqui Prisons, long since fallen into disuse, but still retaining their glamour of barbarous romance. As for the inhabitants, all the world and his wife is to be met here. Every language and dialect can be heard, while, moreover, there is a nondescript population whose descent and nationality it would be impossible to fathom. The blood of many races runs in their veins, and the Panama has, in a way, made them her own; so much so, that they could almost form a nationality of themselves, for whom no better name could be found than "The Panamese."

Such is the Panama Canal as it is to-day. What it has cost is 80 million pounds in hard cash, or four times as much as the Suez Canal. Of human life, too, it has

taken its toll, for it has been said that the Panama Railroad cost a man for every tie that was laid. Besides, it cost something to stamp out disease from this infested zone, and this was only accomplished at the expenditure of much time and money, and at great personal risk. At the outset it seemed a stupendous task, but the genius and fortitude of one man—Colonel Goethals—accomplished the seemingly impossible, and we have this eighth wonder of the world. Even as we write, we are undecided as to its best claim to the title. Is it as an engineering feat, or as a feat of colonisation, or as a State enterprise, or as the enterprise of one man battling against disease? It is impossible to say, and on any one score its claim to be considered a wonder would be secure. Therefore it is more: it is a wonder of wonders; it is a triumph of the twentieth century, and one of the victories of peace.

Marconi's Wireless Telegraph Company announce that their service to Honolulu has not been closed as reported by the United States Government, and that the commercial service is being carried on as usual.

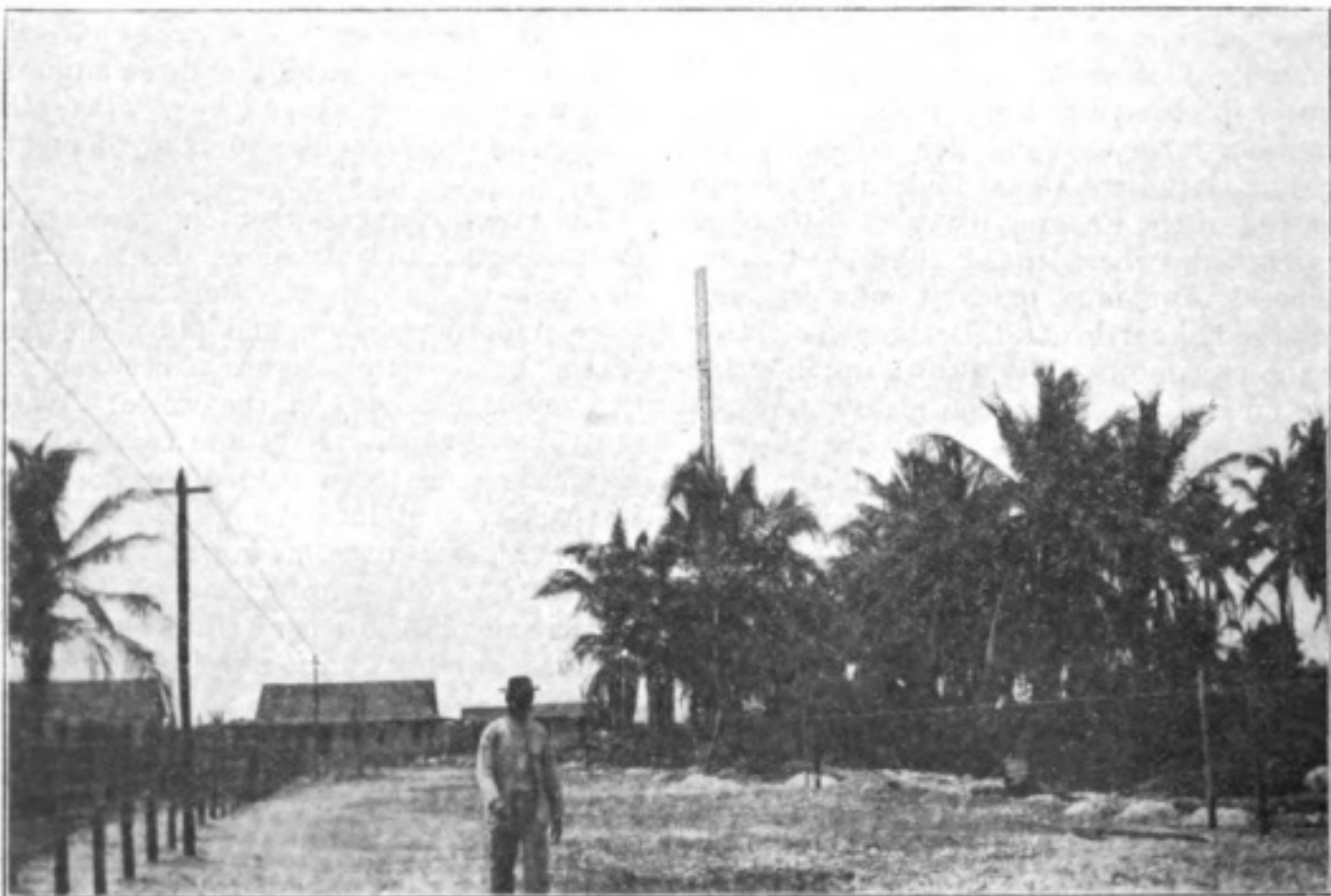

CARTAGENA, COLUMBIA, WIRELESS STATION.
Showing one of the trellis-work steel masts.

QUESTIONS AND ANSWERS

Mr. H. Dobell, who has hitherto conducted the "Questions and Answers" section of THE WIRELESS WORLD, has received a temporary Commission as Lieutenant in the Royal Marines for duty with the Engineer Units of the Royal Naval Division which have been formed from members of the Institutions of Civil, Electrical and Mechanical Engineers. Arrangements have now been made for the answering of questions in THE WIRELESS WORLD to be carried on as usual during Mr. Dobell's absence, and readers are invited to send questions on technical and general problems that arise in the course of their work or in their study to the Editor, THE WIRELESS WORLD, Marconi House, Strand, London, W.C. Such questions must be accompanied by the name and address of the writer, otherwise they will remain unanswered.

S. K. F. (York) wishes to know (1) Why the addition of a second wire to an aerial decreases the inductance? (2) Is platinised carborundum as good a detector as silicon with a gold point? (3) Is there a simple method of cutting out atmospheric disturbances?

Answer.—(1) If we have two inductances in parallel and they have no magnetic influence on one another, the resultant inductance of the pair is calculated as if they were resistances—that is, if L_1 and L_2 are the separate inductances, and L the resultant inductance, we have

$$\frac{1}{L} = \frac{1}{L_1} + \frac{1}{L_2}$$

Hence, if the inductances are equal, the inductance of the pair is half that of either. This might be seen roughly from the fact that there are two paths of equal choking action for the current, so that it might be inferred that the pair would have half the choking effect of either. When, however, the two coils are so placed that they react on one another to add to their choking effect, the resultant inductance will be more than it was without this, but still less than that of a single coil. If the coils are practically similar, but made so that one will just slide inside the other, the coupling between them can be tightened, thus increasing the total inductance, until one is right inside the other. They may then be regarded as a single coil carrying the total current, and the total inductance cannot be further increased. The two inductances in parallel, with a more or less tight coupling, correspond to the case of the twin wire aerial. When these wires are very far apart their resultant inductance will be half that of a single wire. As they are brought closer together the reaction between the two makes the resultant inductance greater, so that when they are about 6 feet apart it will be about .7 of that of a single wire. Finally, when the wires come into contact (coincidence) we have practically a single wire, all the magnetic field of each wire being linked with the other.

(2) A good specimen of carborundum (platinised, or set in Wood's metal) used in conjunction with a potentiometer and high-resistance telephones (say 4,000 ohms each) will be just as sensitive as silicon with a gold point, and infinitely more reliable. The crystal jigger should be of such a size as to tune with a very small condenser.

(3) The method of opposed crystals is probably the simplest way of minimising X's. The function of the highly inductive choke which is connected from the aerial side of the aerial tuning condenser to earth is to prevent static charges accumulating. It does not prevent atmospheric disturbances impulsing the aerial, and so setting the receiving circuits in oscillation, and it is this impulsing the aerial that causes the noise known as X's.

T. H. E. (Chesterfield).—I understand that the length of the earth lead of a transmitter alters the wave-length of signals transmitted. When the lead is buried, is the length calculated to where the lead enters the earth, or, in the case of dry earth, must the calculation be carried down to the point where the lead meets with moist earth?

If the lead were connected to the steel rail of a railway line which, though not insulated, was not properly earthed until it had reached a distance of half a mile from the transmitting station, would this half mile have to be included in the earth lead? Or in the case of a ship station, how much of the ship's hull is included in the earth lead? In other words, where do you draw the line between the lead and the earth?

In my case I have two earth leads—one to a water pipe and the other to buried metal. If these leads are of different length, will my transmitter be radiating two waves at once? If I put a small spark-gap between the oscillating transformer and the earth, will this gap provide a distinct line of demarcation from which to reckon the length? And would the small gap decrease my efficiency?

In the case of the receiver it is impossible to place such a gap; therefore, how will the question affect the receiving circuit?

Answer.—This inquiry is of a type which is often put. Usually it is difficult to give a satisfactory answer without a personal inspection of the station. The length of the earth lead certainly has an effect on the wave-length of the signals transmitted. The actual effective length of the earth-lead is the distance up to the point where the potential becomes zero or the same as that of the earth. In a ship station the distance up to the hull would be effective, but since the hull is a large metallic mass in contact with water (a conductor), and hence at zero potential, no allowance would be required for any part of the hull. The distance up to a connection to a steel railway rail would only have to be reckoned, since the rail forms with the earth a condenser of relatively large capacity and would be raised to a potential above that of the earth by only a small amount, and hence nearly equivalent to zero potential. A small spark-gap in the earth lead does not therefore provide a definite point to separate earth-lead and earth, since there must be a difference of potential between its sides for it to act, hence part of the lower lead is effective. Such a gap would not markedly reduce the efficiency of a station and is regularly used in commercial stations. From the above remarks you will be able to answer for yourself the other questions on this subject which you ask.

G. B. (Port Blair) inquires what measures should be adopted to prevent interference of telephone wires, which

are three hundred yards away from the aerial of a 10 kw. set. He wishes to know if any protection other than running them underground is necessary. Also the distance the four wires into the wireless station office should be run underground.

Answer.—We cannot suggest any further precaution to take besides burying the wires and enclosing them in a metal casing. This metal casing should, however, be connected wherever convenient to the earth system of the aerial. The four station wires should run underground the full distance of three hundred yards from the line to the office; and they should, if possible, be taken at a point so that their direction into the station is at right angles to the aerial.

N. T. S. (Waterford) wishes to obtain very loud signals. He says that he has heard of Clifden being audible at a distance of from 30 to 40 feet away from the telephones in London. His aerial is a good one, but has only one wire in it. Receiving set well made and almost small enough to go into the pocket.

Answer.—By doubling the wire of your aerial it would certainly be improved, especially for long wave-lengths, as less inductance would be required for tuning purposes. If your ambition is to obtain very loud signals—say from Clifden—you would do better with a receiver wound with larger wire than it is possible to get on a receiver so small that it will go into the pocket. You give us no actual particulars of the winding of your jigger. But assuming that it is properly designed, you certainly should get signals from Clifden which can be heard several feet away from the telephones. Probably in the case in London which you cite some form of telephone relay was employed. This would, of course, render signals which were initially very weak audible at large distances from the telephones. An aerial of four wires 150 feet long would not be as good as your present one.

B. B. B. (Wylde Green) gives particulars of his inductively coupled transmitting set. For the purpose of tuning the secondary to the primary circuit he connects a .35 (? 3.5) volt Osram lamp across several turns of the secondary, and notes when it glows most brightly. He finds that none of the amateurs who receive his signals when direct coupled can hear them when he is using the inductively coupled arrangement.

Answer.—Your method of tuning is, as you suggest, probably the cause of failure. When the lamp is connected across the secondary, owing to the low resistance of its filament it will act more or less as a direct short circuit to the secondary turns. This is on account of the fact that it provides a non-inductive path for the high-frequency currents. The ratio of the currents in two circuits is governed far more by their relative inductance than their resistance in the case of the very high frequencies with which we are dealing. In the present case the lamp should be connected across a small inductance placed between the secondary of the oscillation transformer and the earth wire—about ten turns of wire on a $1\frac{1}{2}$ inch former should answer. As the tuning becomes closer, the number of turns across which the lamp is connected should be reduced, so that the change in inductance which takes place when the short-circuiting lamp is finally removed is as small as possible. Hence the circuits are not thrown out of tune. Your other apparatus appears to be quite satisfactory.

S. R. (Barcelona) has increased the length of his aerial, which formerly consisted of six wires in parallel and eighteen metres long, by extending three of them sixty metres further along. The three extensions are of thinner wire than the six short ones. He states that he gets louder signals, but that his signals are "more confused, owing to parasite sounds," and inquires (1) whether the different gauges of wire employed will interfere; (2) if the different lengths would have any effect.

Answer.—(1) The actual effect of the difference in size between the two portions of the aerial wires depends upon whether the wires are of very widely differing sizes or nearly the same. In the latter case it is probable that nothing would be noticed on an aerial of the size given. (2) The three short wires would not interfere with the reception of signals. But the aerial would probably be quite as efficient without them. If by "parasite sounds" atmospheric disturbances are meant, these naturally increase in strength just as the signals do. In the absence of information as to the receiver which is used we can only suggest that a tuned receiver coupled to the aerial be employed and the coupling always being as loose as possible. Much can be done by coupling adjustment in the direction of reducing atmospheric and other extraneous disturbances. The method of joining the extension wires by an independent soldered loop is correct.

G. S. B. (Chester).—(1) My silicon platinum detector works well with a buzzer, 4,000 w-phones, and tuner wound on a tube 3 in. diameter and 60 cms. long, with No. 22 S.W.G. wire. But I have been unable to obtain results from a well-insulated aerial averaging 28 feet in height and a brass curtain pole for my earth. I have tried putting a small condenser across my phones, but without successful results.

(2) What is the formula to find the transmitting distance of a transmitter and the receiving distance of a receiver?

Answer.—Before you go any further in your experimenting, the best thing for you to do is to read carefully, and understand, the course of instruction set out in the book on "The Elementary Principles of Wireless Telegraphy," by R. D. Bangay. Your diagram violates the root principle of a receiving circuit, viz.: that the aerial should possess as little damping, or in other words should be as free to oscillate as possible. You have inserted the large resistance of the crystal right in the earth-lead. The electrical effect of this is similar to the mechanical effect of a viscous liquid on a pendulum. You cannot expect an aerial to oscillate freely if you insert a large resistance in series with it any more than you would expect a pendulum to keep swinging for long if you immersed it in some liquid like treacle. You will gather the force of this after reading the above-mentioned book. For diagrams of connections of a single slider tuner we must refer you to previous numbers of THE WIRELESS WORLD, in which they have been repeatedly given. We presume that the brass curtain pole that you mention is buried in the ground. This should form a fairly good earth. Your question (1) you will be able to answer for yourself after reading the book. (2) There is no simple formula for either of these purposes. Everything depends upon local conditions, and such questions are decided by experience.

BENONI (Newcastle-on-Tyne) wants particulars as to the construction of a highly efficient 600-metre receiving set, with details of telephones and crystals. He also enquires whether phonograph cylinders are suitable for winding coils on.

Answer.—It is impossible to give particulars as to the making of complete sets in these columns. There are several books on the subject, and many excellent sets have been described in the back numbers of THE WIRELESS WORLD. Look up the previous answers to questions and you will get all the information you require. Phonograph cylinders could be used as formers for winding coils, but we should imagine that their brittleness would prove an annoying feature attending their use.

M. O'C. (Ennistymon), D. G. W. (Edinburgh), and others who have sent questions as to the obtaining of licences for stations should apply to the Secretary, General Post Office, London. The authorities will decide what aerial they can allow to be used, and licensees must adapt their apparatus to it. Of course no licences are granted at present.

Among the Operators

Our Naval Heroes

"Dulce et decorum est pro patriâ mori."

THE Marconi service has this month to record a great honour and a great loss. Three of her wireless operators bravely went to their death in the cause of their country when as the result of a naval engagement in the North Sea the battleships *Aboukir*, *Cressy*, and *Hogue* were sunk by a German submarine. At least, it must be presumed that they lost their lives, for up to the present they have not been reported as saved, and by now the lists of the rescued are presumably completed. Theirs was not a showy part in the great theatre of war. The wireless cabin takes up only a small corner of a battleship. But it was a necessary and a vital part, and they played it like men until—"the play was played out!" Their reward is with them. Their noble fulfilment of duty adds a fuller lustre to the service they represent, and in remembering them their brothers-in-arms will also remember that it is the quiet heroism of men such as these who have won for England the honourable place that she holds in the world to-day.

These three men, George Edward Turner, Sidney William Rudderham, and Charles Thomas Massey, were among the first of the large number of Marconi wireless operators who volunteered for wireless service on the Royal Naval Reserve at the outbreak of the war. On August 4th they presented themselves at Chatham, and were immediately commissioned for active service.

There is always an element of risk in the life of a ship's wireless operator, although the apparatus they operate has been the very factor which has diminished such risk; but our lost comrades willingly faced the far greater dangers of war, and the utmost price of their heroism was asked of them. *Exequerunt monumentum aere perennius!*

One of the wireless operators on the *Cressy* was among the rescued, and has given the following vivid account of the engagement:—

When the *Aboukir* was struck we thought it was by a mine, but when the *Hogue*

went we knew it must be a torpedo. The *Aboukir* slid on her side and sank slowly, her funnels almost level with the water and the smoke coming out as from the water's edge. The *Hogue* was struck aft and sank aft. She seemed to give one jump out of the water and then to go straight down. She was struck after the *Aboukir*, but sank first. I was just sending out a message that the *Aboukir* and the *Hogue* had been struck when one of the 9·2-in. guns was fired. The shock of it made me think we had been struck, and I added to my message, "And so have we." Immediately afterwards we were torpedoed. The *Cressy* must have fired a dozen shots or more. She went down slowly, and as things began to fall down the deck, which was turned upwards, I threw off my clothes, climbed the deck, and went down over the keel. There was a target fastened to the ship and some men were using it as a raft, but they could not cut it loose. As the ship went down they were swept away and the target somehow became free. I got on it, and was rescued by the trawler *Coriander*, of Lowestoft. The skipper of that trawler and his men are Britishers all through. They took their ship through the swimming men and saved scores of us. When they got us on board they gave us every bit of clothing they could spare, even some off their own backs. They kept tea going all the while, and one man was hard at it frying fish all the time. During all this time they were in a place of danger. I have read about shipwrecks, and how men keep their heads, but I cannot say I ever imagined things could be so calm and disciplined as they were with us. Men in the water who could swim were helping those who could not. One splendid act was done. A seaman, a powerful swimmer, I saw fighting the waves with a midshipman on his back. When they were brought aboard the trawler the midshipman tried



Charles Thomas Massey (on the right),
Wireless Operator on H.M.S. *Aboukir*.

to find the sailor, but the latter did not show up. He was saved, though, we know that.

Considering the necessarily short warning that could be given, the work of rescue was admirably carried out. An urgent wireless message was sent to Harwich, and all warships in the harbour put to sea at full speed. Some destroyers escorting a warship returned to Harwich Pier that same evening, and by 9.15 all survivors had been brought ashore.

We conclude with short biographical notices of the three deceased operators.

GEORGE EDWARD TURNER (Wireless Telegraph Operator, First Class, H.M.S. *Hogue*) was born at Settle, Yorkshire, in December, 1888, and joined the Marconi Company as a learner at their London school early in 1913. On receiving the Postmaster-General's certificate he was appointed wireless telegraph operator on board the *Aragon*, in which he made one voyage before receiving an appointment to the *Gloucester Castle*. Early in August he volunteered for wireless telegraph duties.

SIDNEY WILLIAM RUDDERHAM (Wireless Telegraph Operator, First Class, H.M.S. *Cressy*) was born in London in 1894, and joined the Marconi Company as a learner in their London school in December, 1913. He served in the *Oceanic* and *West Point* prior to joining the Navy.

CHARLES THOMAS MASSEY (Wireless Telegraph Operator, H.M.S. *Aboukir*) was born at Stonehouse, Devonshire, in 1890, and joined the Marconi Company as a learner in 1910, and served on board the *Kia Ora*, *Majestic*, *Mesaba*, and *Lanfranc*.

The following notice has been issued by the Liverpool and London War

Risks Insurance Association, Ltd. It is addressed to all commanders of vessels forming part of the Association, but as it deals entirely with regulations concerning wireless messages, we commend it to the notice of all operators.

1. It is of the utmost importance that no messages should be sent from any ship on ship service, or by passengers, or by the wireless operators, which give any clue to :

- (a) The position of the ship.
- (b) The course of the ship.
- (c) The past or future movements of the ship, including its dates of departure, arrival, etc., etc.

2. To secure the observance of these regulations members are requested to give *at once* instructions to the Masters of all their vessels which are fitted with wireless :—

FIRST.—To insist that no message be sent until it has been first signed by the Master, or by the First Officer, or by some other officer specially nominated for that purpose by the Master.

SECONDLY.—To take all such steps as are necessary to prevent the wireless operator sending any messages on his own account.

THIRDLY.—To arrange that calls are acknowledged, but no information given in reply without the authority of the Master or duly appointed officer.

FOURTHLY.—To arrange so that all messages received are immediately reported to the Master or duly appointed officer.

FIFTHLY.—To report immediately on arrival in port all cases in which messages have been received from other British ships indicating the position, course, or movements of such other ships.



1. George Edward Turner,
Operator on H.M.S. *Hogue*.
2. Sidney William Rudderham,
Operator on H.M.S. *Cressy*.

The LIBRARY TABLE



"FLYING—SOME PRACTICAL EXPERIENCES." By Gustav Hamel and Charles C. Turner. 341 pp., illustrated. (London: Longmans Green & Co. 12s. 6d. net).

A pathetic interest attaches to this book, for, since its publication, one of the authors has sacrificed his life to the development of an art with which he had gained great distinction. The book is one which we have read with a great deal of interest. The authors have departed from the beaten tracks of aviation literature, and have produced a work dealing with the practical side of aviation, and no two writers could be better qualified for the task.

The book contains twenty chapters and deals with such practical subjects as the choosing of a machine and the cost of flying. The influence of winds, eddies and other disturbances is dealt with. There is a chapter by Mr. Henri Farman on accidents and their prevention. Theoretically every flying accident is preventable, but in practice it has been unavoidable in the nature of things that numerous accidents have occurred, and it cannot for the moment be expected, even with the extensive knowledge of the conditions of flying now possible, that they will be altogether avoided.

An interesting chapter is that dealing with wireless on aeroplanes, which has been compiled from notes contributed by Mr. Marconi. The application of wireless instruments is described and the various designs discussed.

"CAREERS FOR OUR SONS." Edited by Rev. G. H. Williams. (London: Adam and Charles Black. 5s. net.)

This is the fourth edition of a book which is likely to be of service to parents who are called upon to find a suitable vocation for their sons to enter. Particulars are given of the conditions of service in the Marconi Company. Mr. Williams does not make use of unnecessarily alluring bait in order to attract young men into the service, and his plain statement of the conditions and prospects is one that should commend itself to those who are endeavouring to place their sons in some profession.

* * *

"TEST QUESTIONS IN WIRELESS TELEGRAPHY." (Test Cards Series: "Elementary Principles," 228 questions; Series II., "Elementary Principles and Practical Questions on Apparatus," 288 questions). London: The Wireless Press, Ltd., Marconi House, Strand, W.C. 1s. per series.

The object of this useful series of test question cards, with their corresponding books of answers, is to assist the amateur who wishes to take up the study of the principles and applications of wireless telegraphy, for they furnish him with the means of probing his knowledge of the subject as he goes along. Six questions are printed on each card. Having answered them to the best of his ability, the student can then test his results by referring to the corresponding "answers," and subsequently compares his answers with those of other students. If he experiences any difficulties in working out the problem, or finds that his own results differ from those of other students, the Editor of THE WIRELESS WORLD should be communicated with, and he will gladly give the necessary help.

PERSONAL.

Mr. E. J. Nally, Vice-President and General Manager of the Marconi Wireless Telegraph Company of America, has been elected one of the Vice-Presidents of the Old Time Telegraphers and Historical Association, of which Mr. Andrew Carnegie is President and Mr. Thos. A. Edison another of the Vice-Presidents.

Mr. G. C. Mason, of the Engineering Staff, General Post Office, London, has been appointed assistant superintendent in the Wireless Section.

Captain C. G. Crawley, R.M.A., Deputy Inspector of Wireless Telegraphy in the Post Office, who volunteered for active service, has been appointed to H.M.S. *Marlborough*.

Mr. John Graeme Balsillie, A.M.I.E.E., engineer for radio-telegraphy to the Commonwealth Government of Australia, is resigning that appointment at the end of the present year to take up private practice.

At the Key West wireless shore station, which the United States Government has erected, William Keepers, formerly stationed at Key West for seven years, is chief electrician in charge. The staff in order of rank or seniority of service at the station is as follows: I. T. Ward, W. M. Bloomenkranz, J. V. Cooper, J. E. Martin, and J. E. Reid, operators; S. DeLong, clerk; A. T. Beam, messenger. The "Zone" radio officer in charge of all the United States Government wireless stations and also those of the Panama Government is Lieutenant C. W. Cremshaw, with temporary headquarters in Colon.

Mr. C. Tapp has been appointed by the Commonwealth Government wireless inspector at the Australian station, Thursday Island.

Mr. G. E. Clarke, who was for 20 years in the service of the Commercial Cable Company in London, and for the past three years in that company's service at New York, has resigned his position to accept the post of chief operator at the new City office of Marconi's Wireless Telegraph Co., Ltd.

W. H. Payne, Traffic Superintendent, Amalgamated Wireless (Australasia), Ltd., "Wireless House," Clarence Street, Sydney, was recently presented with a fully equipped cutlery cabinet, a fitted travelling bag, and rug, from the directors and employees of the company, on the occasion of his marriage in New Zealand.

George E. Baxter has been appointed manager at the Marconi Transpacific high-power station in California (San Francisco), to which station reference is made in another column. Mr. Baxter, who was born in California in 1890, has had a good deal of wireless experience, and served on various ships and at the Mounterey station before assuming managership of the Hillcrest station (San Francisco) in 1911, from which he has been transferred to the high-power station which forms an important link in the Pacific wireless chain—San Francisco-Honolulu.

R. R. Carlisle, who was instructor at the Marconi School, San Francisco, has vacated that post to take up his duties at the high-power station at Honolulu.

Gerald H. Mawson has been appointed Second Lieutenant in the Northern Wireless Signal Company.

Mr. F. Addey, B.Sc., of the Engineer-in-Chief's Office, has been appointed an Assistant Inspector of Wireless Telegraphy in the Secretary's Office, G.P.O.

According to reports from Ottawa Mr. L. P. Pelletier, the Postmaster-General of Canada, is in very poor health, and the belief is held in official circles that he will be compelled to retire from public life in the near future. Mr. Pelletier has been a member of Sir Robert Borden's Government since its formation. Mr. T. Chase Casgrain will succeed to the portfolio.

PATENT INTELLIGENCE.

No. 11371/1913. (Mr. G. Marconi). Specification No. 28865, dated December 14th, 1912, describes an arrangement wherein a condenser is charged through suitable inductances and resistances from a source of current, preferably a high tension battery, and discharged through an inductance, which may be coupled directly to an aerial, and a revolving toothed disc or discs in series. It also describes how a continuous stream of oscillations may be produced by this apparatus by arranging the speed of rotation of the disc so that the interval between two successive discharges is equal to or is a multiple of the natural time period of the aerial and of the closed discharged circuit.

MORSE CODE CARD, showing Alphabet, Numerals, Abbreviations, etc., at a glance. Price 2d. post free.—THE WIRELESS PRESS, LTD., Marconi House, Strand, W.C.

ANY BOOKS reviewed, in the WIRELESS WORLD or other magazines, will be forwarded per return upon receipt of remittance covering cost of book and postage.—THE WIRELESS PRESS, LTD., Marconi House, Strand, W.C.

EFFICIENCY IN WIRELESS TELEGRAPHY.—The Test Cards just published, will be a valuable aid to all students.—See advertisement page vi for full particulars.

YEAR-BOOK OF WIRELESS TELEGRAPHY AND TELEPHONY, 1914. A few returned copies available, otherwise out of print. Price 3/- post free.—THE WIRELESS PRESS, LTD., Marconi House, Strand, W.C.

MAP OF THE WORLD, showing principal Wireless Stations. Price 1/8 post free. THE WIRELESS PRESS, LTD., Marconi House, Strand, W.C.

FINAL DIGEST FOR MARCONI STUDENTS. First Edition, 9d. post free. Second Edition, enlarged and improved, embracing Handbook, Complete Guide to Government Examination. Useful to Operators. 2/6 post free. *Glasgow Herald*: "As revised and brought up to date the volume should prove more than ever useful to candidates for examination in wireless telegraphy." Sole Publishers, WALLASEY SPECIALITY CO., 11 Leasowes Avenue, Wallasey, Cheshire.